

ADRCV1250TD

12V 50W TRIAC Dimmable Constant Voltage LED Driver

Drive12



PRODUCT FEATURES

- 12V Constant Voltage
- Available In 25W, 50W And 100W
- Dimmable - Compatible With Trailing & Leading Edge Dimmers
- SELV, Overload, No Load, Short Circuit, Thermal & Overload Protection
- Screw Terminals

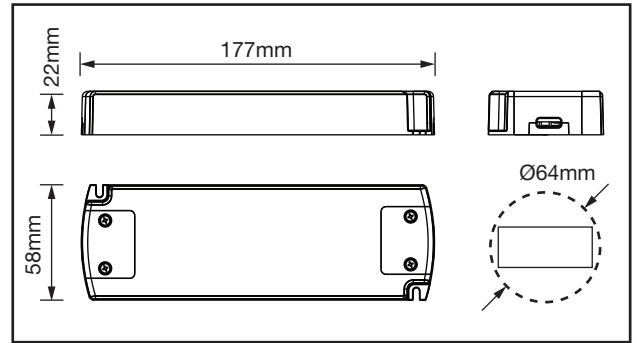

TECHNICAL SPECIFICATIONS

Product Code	ADRCV1250TD
Operating Voltage	220-240V AC
Operating Current (A max)	0.255A
Operating Output Power	2.5W - 50W
Output Current (Max)	4.16A
Output Voltage (Max)	12V
Power Factor	0.9
Efficiency %	90%
No Load Power (W)	<0.5W
Class	II
Body Material	Polymer
Frame Colour	White (Orange Caps)
Switching Cycles	>15,000
Ingress Protection	IP20
Ambient Operating Temperature (°C)	-20°C~+45°C
Input Frequency (Hz)	50/60Hz
Guarantee	5 Years
Dimmable	Yes
Dimming Mode (Trailing Or Leading)	Trailing And Leading
Output Type	Constant Voltage
Lifetime	30,000 Hrs

