

ADRCV1280

12V 80W Constant Voltage LED Driver

Drive12



PRODUCT FEATURES

- 12V Constant Voltage
- Zero Load Function
- Non-Dimmable
- SELV, Overload, No Load, Short Circuit, Thermal & Overload Protection
- Screw Terminals

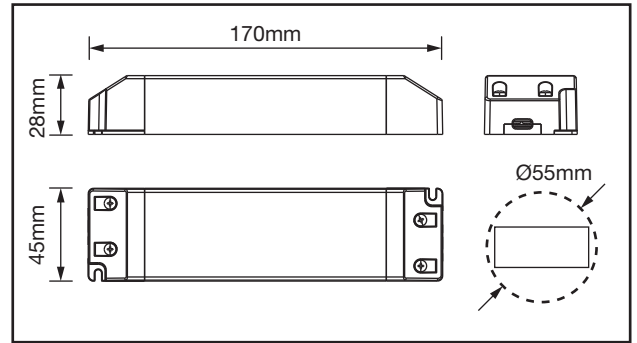

TECHNICAL SPECIFICATIONS

| Product Code | ADRCV1280 |
|------------------------------------|---------------------|
| Operating Voltage | 220-240V AC |
| Operating Current (A Max) | 0.382 |
| Operating Output Power | 0W - 80W |
| Output Current (Max) | 6.66A |
| Output Voltage (Max) | 12V |
| Power Factor | 0.95 |
| Efficiency % | 86% |
| No Load Power (W) | <0.5W |
| Class | II |
| Body Material | Polymer |
| Frame Colour | White (Orange Caps) |
| Switching Cycles | >25,000 |
| Ingress Protection | IP20 |
| Ambient Operating Temperature (°C) | -20°C~+45°C |
| Input Frequency (Hz) | 50/60Hz |
| Guarantee | 5 Years |
| Output type | Constant Voltage |
| Lifetime | 50,000 Hrs |

