

ADRCV24320

24V 320W Constant Voltage LED Driver

Drive24

PRODUCT FEATURES

- 24V Constant Voltage
- Zero Load Function
- Non-Dimmable
- SELV, Overload, No Load, Short Circuit, Thermal & Overload Protection
- Screw Terminals

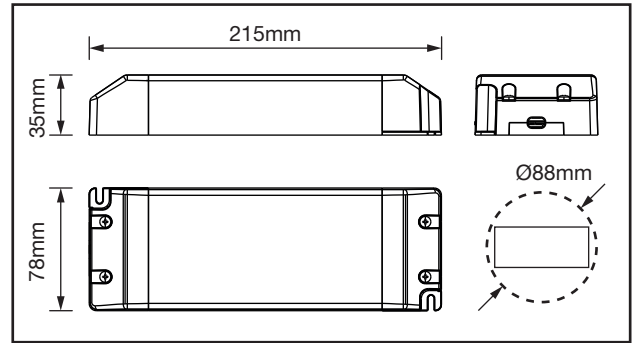

TECHNICAL SPECIFICATIONS

Product Code	ADRCV24320
Operating Voltage	220-240V AC
Operating Current (A Max)	1.45A
Operating Output Power	0W - 320W
Output Current (Max)	13.3A
Output Voltage (Max)	24V
Power Factor	0.95
Efficiency %	95%
No Load Power (W)	<0.5W
Class	II
Body Material	Polymer
Frame Colour	White (Blue Caps)
Switching Cycles	>25,000
Ingress Protection	IP20
Ambient Operating Temperature (°C)	-20°C~+45°C
Input Frequency (Hz)	50/60Hz
Guarantee	5 Years
Output Type	Constant Voltage
Lifetime	50,000 Hrs

