

Driver LCA 85W 600–1800mA 2xCH Ip PRE

MULTI channel premium series

**Product description**

- _ NEW: lumDATA (DALI-2 part ext. 251, 252 and 253)
- _ Dimmable built-in constant current 2-channel LED driver with DALI DT6
- _ Dimming range 1 to 100 %
- _ Suitable for luminaires of protection class I and protection class II (see data sheet chapter 3.4 for details)
- _ Output current adjustable between 600 – 1,800 mA for each channel
- _ Max. output power 85 W
- _ Up to 89 % efficiency
- _ Power input on stand-by < 0.5 W
- _ Nominal lifetime up to 100,000 h
- _ 5 years guarantee (Conditions at <https://www.tridonic.com/en/int/services/manufacturer-guarantee-conditions>)

Housing properties

- _ Low profile metal casing with white cover
- _ Type of protection IP20

Interfaces

- _ one4all (DALI-2 DT 6, DSI, switchDIM, corridorFUNCTION V2)
- _ proportionSWITCH
- _ Terminal blocks: 0° push terminals

Functions

- _ Adjustable output current in 1-mA-steps (DALI) or with resistor plug (I-SELECT 2)
- _ Constant light output function (CLO)
- _ proportionSWITCH with pre defined scenes (split between different channel scenes)
- _ switchDIM and proportionSWITCH with memory function
- _ Power-up fading and fade2zero
- _ Configurable via DALI
- _ Protective features (overtemperature, short-circuit, overload, no-load, reduced surge amplification)
- _ Intelligent Voltage Guard (overvoltage and undervoltage monitoring)
- _ Suitable for emergency escape lighting systems acc. to EN 50172

Benefits

- _ Flexible configuration via companionSUITE
- _ Application-oriented operating window for maximum compatibility
- _ Best energy savings due to low stand-by losses
- _ Flexible configuration via DALI and I-SELECT 2

Typical applications

- _ For linear/area lighting in office and health care applications
- _ Direct and indirect lighting application

Website

<http://www.tridonic.com/28002829>



Linear



High bay



Decorative



Downlights



Spotlights



Free-standing



Area



Floor | Wall



Street

Driver LCA 85W 600–1800mA 2xCH Ip PRE

MULTI channel premium series

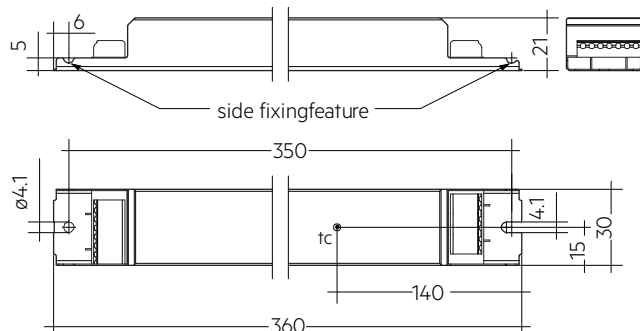

Ordering data

Type	Article number	Packaging, carton	Packaging, pallet	Weight per pc.
LCA 85W 600-1800mA 2xCH Ip PRE	28002829	10 pc(s).	480 pc(s).	0.277 kg

Technical data

Rated supply voltage	220 – 240 V
AC voltage range	198 – 264 V
DC voltage range	176 – 288 V
Mains frequency	0 / 50 / 60 Hz
Overvoltage protection	320 V AC, 48 h
Typ. current (at 230 V, 50 Hz, full load) ^{①②}	295 – 438 mA
Typ. current (220 V, 0 Hz, full load, 15 % dimming level) ^②	71 mA
Leakage current (at 230 V, 50 Hz, full load) ^{①②}	< 330 μ A
Typ. efficiency (at 230 V, 50 Hz, full load) ^②	89 %
λ (at 230 V, 50 Hz, full load) ^①	0.98
Typ. power consumption on stand-by ^③	< 0.25 W
Typ. input current in no-load operation	25 mA
Typ. input power in no-load operation	< 0.5 W
In-rush current (peak / duration)	31.5 A / 215 μ s
THD (at 230 V, 50 Hz, full load) ^①	< 10 %
Starting time (at 230 V, 50 Hz, full load) ^①	< 0.6 s
Starting time (DC mode)	< 0.4 s
Switchover time (AC/DC) ^④	< 0.2 s
Turn off time (at 230 V, 50 Hz, full load)	< 20 ms
Output current tolerance ^{①⑤}	\pm 3 %
Max. output current peak (non-repetitive)	\leq output current + 20 %
Output LF current ripple (< 120 Hz)	\pm 2.5 %
Output P_ST_LM (at full load)	\leq 1
Output SVM (at full load)	\leq 0.4
Max. output voltage (U-OUT)	60 V
Dimming range	1 – 100 %
Mains surge capability (between L - N)	1 kV
Mains surge capability (between L/N - PE)	2 kV
Surge voltage at output side (against PE)	< 0.5 kV
Type of protection	IP20
Lifetime	up to 100,000 h
Guarantee (conditions at www.tridonic.com)	5 Year(s)
Dimensions L x W x H	360 x 30 x 21 mm

Approval marks



Standards

EN 55015, EN 61000-3-2, EN 61000-3-3, EN 61347-1, EN 61347-2-13, EN 62384, EN 61547, EN 62386-101, EN 62386-102, EN 62386-207 (DALI-2), according to EN 50172, according to EN 60598-2-22

Specific technical data

Type	Output current for each channel ^①	Min. forward voltage per channel	Max. forward voltage per channel	Max. output power per channel	Typ. power consumption (at 230 V, 50 Hz, full load)	Typ. current consumption (at 230 V, 50 Hz, full load)	tc point max.	Ambient temperature ta	I-SELECT 2 resistor value ^⑦
LCA 85W 600-1800mA 2xCH Ip PRE	600 mA	20 V	50.0 V	30.0 W	66.4 W	295 mA	79 °C	-25 ... +60 °C	-
LCA 85W 600-1800mA 2xCH Ip PRE	650 mA	20 V	50.0 V	32.5 W	71.9 W	319 mA	83 °C	-25 ... +55 °C	7.69 kΩ
LCA 85W 600-1800mA 2xCH Ip PRE	700 mA	20 V	50.0 V	35.0 W	77.3 W	343 mA	83 °C	-25 ... +55 °C	7.14 kΩ
LCA 85W 600-1800mA 2xCH Ip PRE	750 mA	20 V	50.0 V	37.5 W	82.8 W	367 mA	83 °C	-25 ... +55 °C	6.67 kΩ
LCA 85W 600-1800mA 2xCH Ip PRE	800 mA	20 V	50.0 V	40.0 W	88.4 W	391 mA	83 °C	-25 ... +55 °C	6.25 kΩ
LCA 85W 600-1800mA 2xCH Ip PRE	850 mA	20 V	50.0 V	42.5 W	94.0 W	415 mA	83 °C	-25 ... +50 °C	5.88 kΩ
LCA 85W 600-1800mA 2xCH Ip PRE	900 mA	20 V	50.0 V	45.0 W	94.2 W	417 mA	83 °C	-25 ... +50 °C	5.56 kΩ
LCA 85W 600-1800mA 2xCH Ip PRE	950 mA	20 V	50.0 V	47.5 W	94.6 W	418 mA	83 °C	-25 ... +50 °C	5.26 kΩ
LCA 85W 600-1800mA 2xCH Ip PRE	1,000 mA	20 V	50.0 V	50.0 W	94.8 W	419 mA	83 °C	-25 ... +50 °C	5.00 kΩ
LCA 85W 600-1800mA 2xCH Ip PRE	1,050 mA	20 V	50.0 V	52.5 W	95.0 W	420 mA	83 °C	-25 ... +50 °C	4.76 kΩ
LCA 85W 600-1800mA 2xCH Ip PRE	1,100 mA	20 V	50.0 V	55.0 W	95.3 W	421 mA	83 °C	-25 ... +50 °C	4.55 kΩ
LCA 85W 600-1800mA 2xCH Ip PRE	1,150 mA	20 V	50.0 V	57.5 W	95.6 W	423 mA	83 °C	-25 ... +50 °C	4.35 kΩ
LCA 85W 600-1800mA 2xCH Ip PRE	1,200 mA	20 V	50.0 V	60.0 W	95.9 W	424 mA	83 °C	-25 ... +50 °C	4.17 kΩ
LCA 85W 600-1800mA 2xCH Ip PRE	1,250 mA	20 V	50.0 V	62.5 W	96.2 W	425 mA	83 °C	-25 ... +50 °C	4.00 kΩ
LCA 85W 600-1800mA 2xCH Ip PRE	1,300 mA	20 V	50.0 V	65.0 W	96.4 W	426 mA	83 °C	-25 ... +50 °C	3.85 kΩ
LCA 85W 600-1800mA 2xCH Ip PRE	1,350 mA	20 V	50.0 V	67.5 W	96.6 W	427 mA	83 °C	-25 ... +50 °C	3.70 kΩ
LCA 85W 600-1800mA 2xCH Ip PRE	1,400 mA	20 V	50.0 V	70.0 W	69.9 W	429 mA	83 °C	-25 ... +50 °C	3.57 kΩ
LCA 85W 600-1800mA 2xCH Ip PRE	1,450 mA	20 V	50.0 V	72.5 W	97.2 W	430 mA	83 °C	-25 ... +45 °C	3.45 kΩ
LCA 85W 600-1800mA 2xCH Ip PRE	1,500 mA	20 V	50.0 V	75.0 W	97.5 W	431 mA	83 °C	-25 ... +45 °C	3.33 kΩ
LCA 85W 600-1800mA 2xCH Ip PRE	1,550 mA	20 V	50.0 V	77.5 W	97.7 W	432 mA	83 °C	-25 ... +45 °C	3.23 kΩ
LCA 85W 600-1800mA 2xCH Ip PRE	1,600 mA	20 V	50.0 V	80.0 W	98.0 W	433 mA	83 °C	-25 ... +45 °C	3.13 kΩ
LCA 85W 600-1800mA 2xCH Ip PRE	1,650 mA	20 V	50.0 V	82.5 W	98.3 W	434 mA	83 °C	-25 ... +45 °C	3.03 kΩ
LCA 85W 600-1800mA 2xCH Ip PRE	1,700 mA	20 V	50.0 V	85.0 W	98.6 W	436 mA	83 °C	-25 ... +45 °C	2.94 kΩ
LCA 85W 600-1800mA 2xCH Ip PRE	1,750 mA	20 V	48.6 V	85.0 W	98.9 W	437 mA	83 °C	-25 ... +45 °C	2.86 kΩ
LCA 85W 600-1800mA 2xCH Ip PRE	1,800 mA	20 V	47.2 V	85.0 W	99.1 W	438 mA	83 °C	-25 ... +45 °C	0.00 kΩ

① Valid at 100 % dimming level.

② Depending on the selected output current.

③ Depending on the DALI traffic at the interface.

④ Valid for immediate change of power supply type otherwise the starting time is valid.

⑤ Output current is mean value.

⑥ The table only lists a number of possible operating points but does not cover each single point. The output current can be set within the total value range in 1-mA-steps.

⑦ Not compatible with I-SELECT (generation 1). Calculated resistor value.

I-SELECT 2 PLUG PRE / EXC

Accessory



Product description

- _ Ready-for-use resistor to set output current value
- _ Compatible with LED driver featuring I-select 2 interface; not compatible with I-SELECT (generation 1)
- _ Resistor is base insulated
- _ Resistor power 0.25 W
- _ Current tolerance $\pm 2\%$ additional to output current tolerance
- _ Compatible with LED driver series PRE and EXC

Example of calculation

- _ $R [k\Omega] = 5 V / I_{out} [mA] \times 1000$
- _ E96 resistor value used
- _ Resistor value tolerance $\leq 1\%$; resistor power $\geq 0.1 W$; base insulation necessary
- _ When using a resistor value beyond the specified range, the output current will automatically be set to the minimum value (resistor value too big), respectively to the maximum value (resistor value too small)

Website

<http://www.tridonic.com/28001116>



Ordering data

Type	Article number	Colour	Marking	Current	Resistor value	Packaging, bag	Weight per pc.
I-SELECT 2 PLUG 600MA BL	28001116	Blue	0600 mA	600 mA	8.25 k Ω	10 pc(s).	0.001 kg
I-SELECT 2 PLUG 650MA BL	28001117	Blue	0650 mA	650 mA	7.68 k Ω	10 pc(s).	0.001 kg
I-SELECT 2 PLUG 700MA BL	28001118	Blue	0700 mA	700 mA	7.15 k Ω	10 pc(s).	0.001 kg
I-SELECT 2 PLUG 750MA BL	28001119	Blue	0750 mA	750 mA	6.65 k Ω	10 pc(s).	0.001 kg
I-SELECT 2 PLUG 800MA BL	28001120	Blue	0800 mA	800 mA	6.19 k Ω	10 pc(s).	0.001 kg
I-SELECT 2 PLUG 850MA BL	28001121	Blue	0850 mA	850 mA	5.90 k Ω	10 pc(s).	0.001 kg
I-SELECT 2 PLUG 900MA BL	28001122	Blue	0900 mA	900 mA	5.62 k Ω	10 pc(s).	0.001 kg
I-SELECT 2 PLUG 950MA BL	28001123	Blue	0950 mA	950 mA	5.23 k Ω	10 pc(s).	0.001 kg
I-SELECT 2 PLUG 1000MA BL	28001124	Blue	1000 mA	1,000 mA	4.99 k Ω	10 pc(s).	0.001 kg
I-SELECT 2 PLUG 1050MA BL	28001125	Blue	1050 mA	1,050 mA	4.75 k Ω	10 pc(s).	0.001 kg
I-SELECT 2 PLUG 1100MA BL	28001126	Blue	1100 mA	1,100 mA	4.53 k Ω	10 pc(s).	0.001 kg
I-SELECT 2 PLUG 1150MA BL	28001127	Blue	1150 mA	1,150 mA	4.32 k Ω	10 pc(s).	0.001 kg
I-SELECT 2 PLUG 1200MA BL	28001128	Blue	1200 mA	1,200 mA	4.12 k Ω	10 pc(s).	0.001 kg
I-SELECT 2 PLUG 1250MA BL	28001129	Blue	1250 mA	1,250 mA	4.02 k Ω	10 pc(s).	0.001 kg
I-SELECT 2 PLUG 1300MA BL	28001130	Blue	1300 mA	1,300 mA	3.83 k Ω	10 pc(s).	0.001 kg
I-SELECT 2 PLUG 1350MA BL	28001131	Blue	1350 mA	1,350 mA	3.74 k Ω	10 pc(s).	0.001 kg
I-SELECT 2 PLUG 1400MA BL	28001132	Blue	1400 mA	1,400 mA	3.57 k Ω	10 pc(s).	0.001 kg
I-SELECT 2 PLUG 1500MA BL	28001133	Blue	1500 mA	1,500 mA	3.32 k Ω	10 pc(s).	0.001 kg
I-SELECT 2 PLUG 1600MA BL	28001134	Blue	1600 mA	1,600 mA	3.16 k Ω	10 pc(s).	0.001 kg
I-SELECT 2 PLUG 1700MA BL	28001135	Blue	1700 mA	1,700 mA	2.94 k Ω	10 pc(s).	0.001 kg
I-SELECT 2 PLUG 1800MA BL	28001136	Blue	1800 mA	1,800 mA	2.80 k Ω	10 pc(s).	0.001 kg
I-SELECT 2 PLUG MAX BL	28001099	Blue	MAX	MAX	0.00 k Ω	10 pc(s).	0.001 kg

1. Standards

EN 55015
 EN 61000-3-2
 EN 61000-3-3
 EN 61347-1
 EN 61347-2-13
 EN 62384
 EN 61547
 EN 62386-101 (DALI-2)
 EN 62386-102 (DALI-2)
 EN 62386-207

According to EN 50172 for use in central battery systems

According to EN 60598-2-22 suitable for emergency lighting installations

2. Thermal details and lifetime

2.1 Expected lifetime

Expected lifetime							
Type	Output current	ta	40 °C	45 °C	50 °C	55 °C	60 °C
	600 – 1,200 mA	tc	62 °C	66 °C	70 °C	74 °C	79 °C
		Lifetime	> 100,000 h	> 100,000 h	> 100,000 h	> 100,000 h	70,000 h
LCA 85W 600-1800mA 2xCH Ip PRE	> 1,200 – 1,500 mA	tc	70 °C	74 °C	78 °C	83 °C	–
		Lifetime	> 100,000 h	> 100,000 h	70,000 h	50,000 h	–
	> 1,500 – 2,800 mA	tc	74 °C	78 °C	83 °C	–	–
		Lifetime	90,000 h	60,000 h	50,000 h	–	–
	> 2,800 – 3,600 mA	tc	79 °C	83 °C	–	–	–
		Lifetime	80,000 h	60,000 h	–	–	–

The LED driver is designed for a lifetime stated above under reference conditions and with a failure probability of less than 10 %.

The relation of tc to ta temperature depends also on the luminaire design.

If the measured tc temperature is approx. 5 K below tc max., ta temperature should be checked and eventually critical components (e.g. ELCAP) measured. Detailed information on request.

3. Installation / wiring

3.1 Circuit diagram

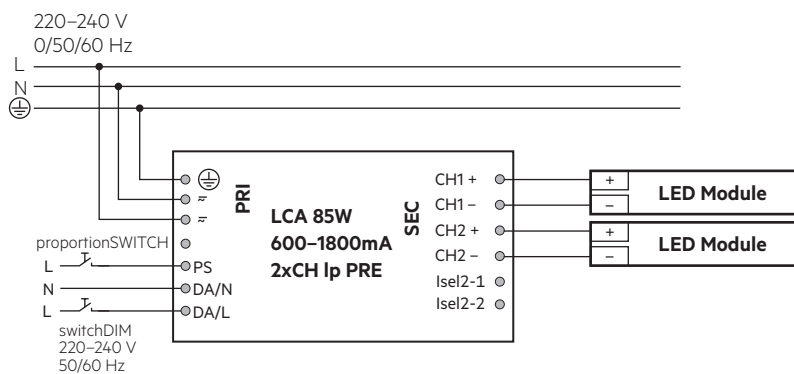
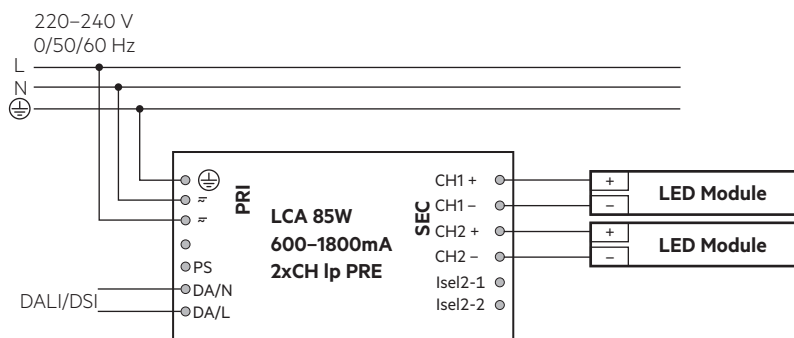

Wiring diagram for emergency

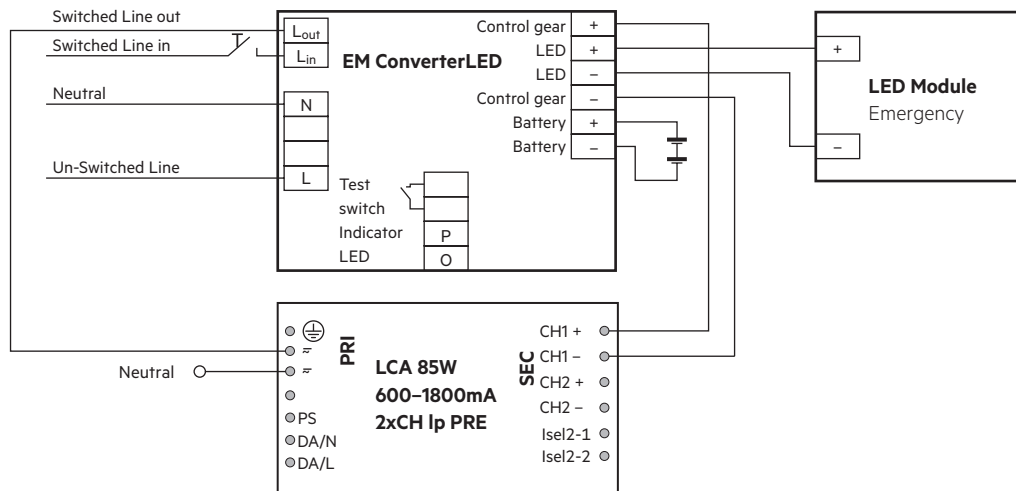

3.2 Wiring type and cross section

For wiring use solid wire from 0.5 – 1.5 mm².

Strip 8 – 9 mm of insulation from the cables to ensure perfect operation of terminals.

LED module/LED driver/supply

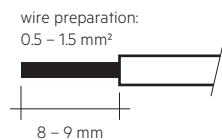

3.3 Loose wiring

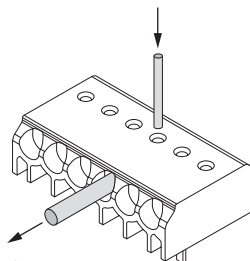

Loosen wire through twisting and pulling or using a \varnothing 1 mm release tool

3.4 Wiring guidelines

- Run the secondary lines separately from the mains connections and lines to achieve good EMC performance.
- The max. secondary cable length is 2 m (4 m circuit), this applies for LED output as well as for I-SELECT 2.
- For good EMC performance, keep the LED wiring as short as possible.
- Secondary switching is not permitted.
- The LED driver has no inverse-polarity protection on the secondary side. Wrong polarity can damage LED modules with no inverse-polarity protection.
- Wrong wiring of the LED driver can lead to malfunction or irreparable damage.

- In case of protection class II applications it's recommended to separate the lamp wires of the different channels. Depending onto the luminaire construction additional actions, such as equipotential connection between driver and LED or a toroidal ferrite at the lamp wires are recommended.
- To avoid the damage of the Driver, the wiring must be protected against short circuits to earth (sharp edged metal parts, metal cable clips, louver, etc.).

3.5 Hot plug-in

Hot plug-in is not supported due to residual output voltage of > 0 V. When connecting an LED load, restart the device to activate the LED output. This can be done via mains reset or via interface (DALI, DSI, switchDIM).

3.6 Earth connection

The earth connection is conducted as protection earth (PE). The LED driver can be earthed via earth terminal or metal housing. If the LED driver will be earthed, protection earth (PE) has to be used. There is no earth connection required for the functionality of the LED driver.

Earth connection is recommended to improve following behaviour:

- Electromagnetic interferences (EMI)
- LED glowing at stand-by
- Transmission of mains transients to the LED output

In general it is recommended to earth the LED driver if the LED module is mounted on earthed luminaire parts respectively heat sinks and thereby representing a high capacity against earth.

3.7 I-SELECT 2 resistors connected via cable

For details see:

http://www.tridonic.com/com/en/download/technical/LCA_PRE_LC_EXC_ProductManual_en.pdf

4. Electrical values

4.1 Operating window

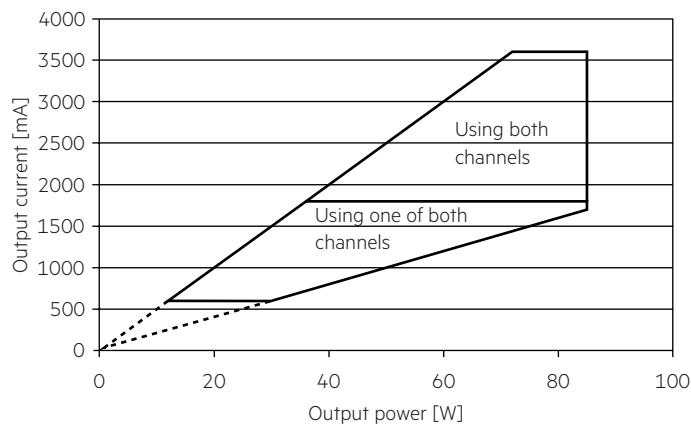
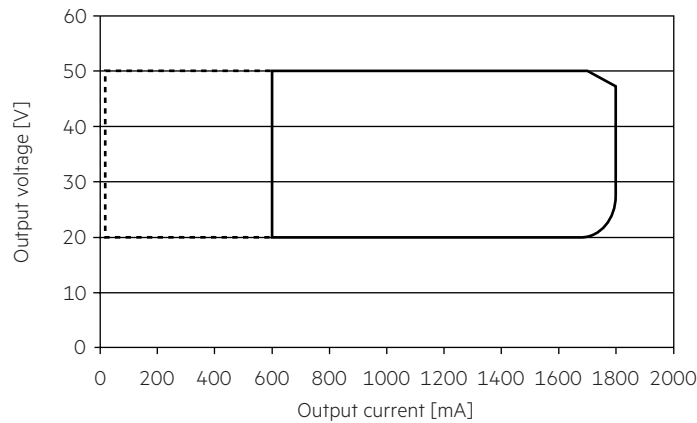

— Operating window 100 %
 - - - - - Operating window dimmed

Make sure that the LED driver is operated within the given window under all operating conditions. Special attention needs to be paid at dimming and DC emergency operation as the forward voltage of the connected LED modules varies with the dimming level, due to the implemented amplitude dimming technology. Coming below the specified minimum output voltage of the LED driver may cause the device to shut-down. See chapter "6.8 DC operation" for more information.

4.2 Efficiency vs load

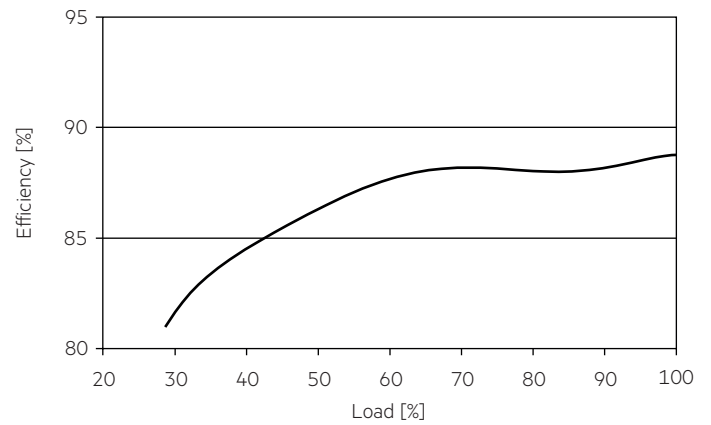

4.3 Power factor vs load

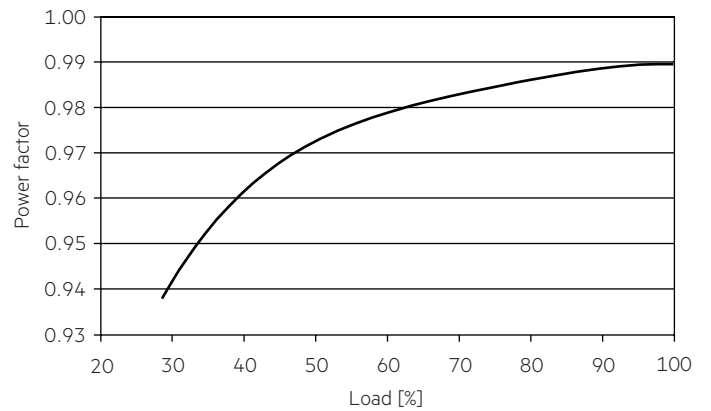

4.4 THD vs load

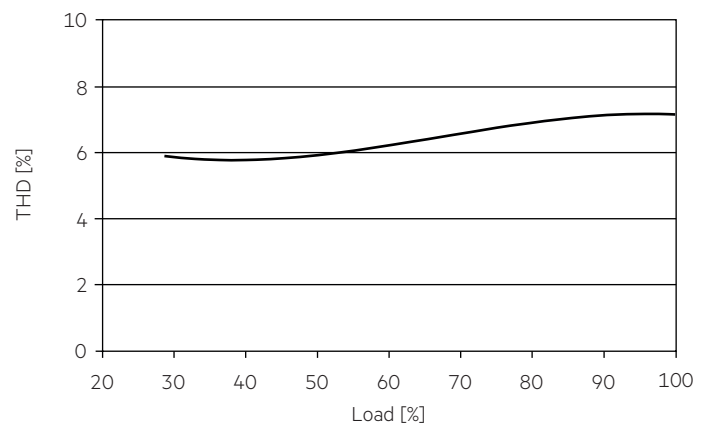

100 % load corresponds to the max. output power (full load) according to the table on page 2.

4.5 Maximum loading of automatic circuit breakers in relation to inrush current

Automatic circuit breaker type	C10	C13	C16	C20	B10	B13	B16	B20	Inrush current	
Installation \varnothing	1.5 mm ²	1.5 mm ²	2.5 mm ²	4 mm ²	1.5 mm ²	1.5 mm ²	2.5 mm ²	4 mm ²	I_{max}	time
LCA 85W 600-1800mA 2xCH Ip PRE	15	20	25	32	9	12	15	19	31.5 A	215 μ s

These are max. values calculated out of inrush current! Please consider not to exceed the maximum rated continuous current of the circuit breaker.

Calculation uses typical values from ABB series S200 as a reference.

Actual values may differ due to used circuit breaker types and installation environment.

4.6 Harmonic distortion in the mains supply (at 230 V / 50 Hz and full load) in %

	THD	3.	5.	7.	9.	11.
LCA 85W 600-1800mA 2xCH Ip PRE	< 10	< 10	< 3	< 2	< 2	< 2

4.7 Dimming

Dimming range 1% to 100 %

Digital control with:

- DSI signal: 8 bit Manchester Code
Speed 1% to 100% in 1.4 s
- DALI signal: 16 bit Manchester Code
Speed 1% to 100% in 0.2 s

Programmable parameter:

Minimum dimming level

Maximum dimming level

Default minimum = 1%

Programmable range $1\% \leq \text{MIN} \leq 100\%$

Default maximum = 100%

Programmable range $100\% \geq \text{MAX} \geq 1\%$

Dimming curve is adapted to the eye sensitiveness.

Dimming is realized by amplitude dimming.

4.8 Dimming characteristics

Digital dimming value

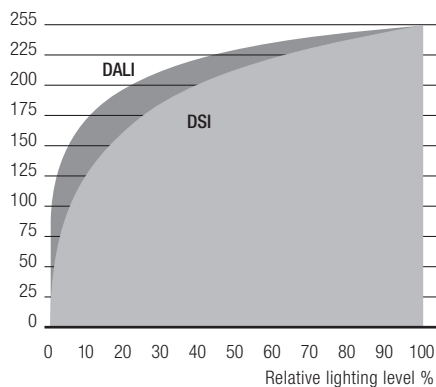

Dimming characteristics as seen by the human eye

5. Software / Programming / Interfaces

5.1 Software / programming

With appropriate software and interface different functions can be activated and various parameters can be configured in the LED driver. The Driver supports the following software and interfaces:

Software / hardware for configuration:

- companionSUITE (deviceGENERATOR, deviceCONFIGURATOR, deviceANALYSER)
- masterCONFIGURATOR

Interfaces for data transfer:

- Control input DALI

5.2 Control input DALI

The control input is non-polar for digital control signals (DALI). The control signal is not SELV. The control cable has to be installed in accordance to the requirements of low voltage installations.

Digital control with:

- DALI signal: 16 bit
- DSI signal: 8 bit

5.3 I-SELECT 2

By inserting a suitable resistor into the I-SELECT 2 interface, the current value can be adjusted. The relationship between output current and resistor value can be found in the chapter "Accessories I-SELECT 2 Plugs". If the resistor is connected by wires a consistent base insulation must be ensured. Furthermore, a max. wire length of 2 m may not be exceeded and potential interferences have to be avoided.

Resistors for the main output current values can be ordered from Tridonic (see accessories).

6. Functions

☉ companionSUITE:

















DALI-USB

The companionSUITE with deviceGENERATOR, deviceCONFIGURATOR and deviceANALYSER is available via our WEB page:
<https://www.tridonic.com/com/en/products/companionsuite.asp>

◇ masterCONFIGURATOR:

DALI-USB

The masterCONFIGURATOR is available via our WEB page:
<https://www.tridonic.com/com/en/software-masterconfigurator.asp>

Icon	Function	DALI-2
	OEM Identification	☉ ◇
	OEM GTIN	☉ ◇
	Luminaire data	☉ -
	LED current	☉ ◇
	Device operating mode	☉ ◇
	switchDIM	☉ ◇
	corridorFUNCTION	☉ ◇
	Constant light output (CLO)	☉ ◇
	DC level	☉ ◇
	Enhanced power on level (ePOL)	☉ ◇
	DALI default parameters	☉ ◇
	Scenes and groups	☉ ◇
	Intelligent voltage guard (IVG)	☉ ◇
	Dimming curve	☉ -
	Channel Grouping	☉ -
	proportionSWITCH	- ◇

6.1 OEM Identification



The OEM (Original Equipment Manufacturer) can set his own identification number.

DALI Part 251: Memory bank 1 extension.

6.2 OEM GTIN



The Original Equipment Manufacturer (OEM) can set his own Global Trade Item Number (GTIN).

DALI Part 251: Memory bank 1 extension.

6.3 Luminaire data



This function provides the asset management with accurate data about the luminaire.

DALI Part 251: Memory bank 1 extension.

6.4 LED current



The LED output current must be adapted to the connected LED module. The value is limited by the current range of the respective device.

The output current of the LED driver can be adjusted in a certain range. For adjustment there are 2 options available.

Option 1: DALI

Adjustment is done by companionSUITE or by masterCONFIGURATOR.

Option 2: I-SELECT 2

By inserting a suitable resistor into the I-SELECT 2 interface, the current value can be adjusted.

The priority for current adjustment methods is DALI (highest priority) and I-SELECT 2 (lowest priority).

6.5 Device operating mode



A Tridonic Driver supports several control signals. These control signals are automatically detected and the mode is adapted. If only one special device mode is required, this mode can be selected. "Automatic detection" is the default setting.

6.6 switchDIM



Integrated switchDIM function allows a direct connection of a pushbutton for dimming and switching.

Brief push (< 0.6 s) switches LED driver ON and OFF. The dimm level is saved at power-down and restored at power-up. When the pushbutton is held, LED modules are dimmed. After repush the LED modules are dimmed in the opposite direction.

In installations with LED drivers with different dimming levels or opposite dimming directions (e.g. after a system extension), all LED drivers can be synchronized to 50 % dimming level by a 10 s push.

Use of pushbutton with indicator lamp is not permitted.

6.7 corridorFUNCTION



With the corridorFUNCTION and a commercially available motion detector, it is easy to adapt the lighting in one area to its use.

That is, when the area is entered by a person, the lighting dims instantly to the desired brightness and is available in full strength.

After the area is left by the person, the brightness dims slowly to a smaller value or switches off completely.

The individual parameters of the desired profile, such as brightness values or delay times, can be adjusted flexibly and individually.

6.8 Constant Light Output (CLO)



With this function the light output of the LED module can be kept equal over the lifetime.

The light output of an LED module reduces over the course of its lifetime.

The Constant Light Output (CLO) function compensates for this natural decline by constantly increasing the output current of the LED driver throughout its lifetime.

CLO shall be achieved by limitation of the LED current at the commissioning of the LED driver and providing a linear interpolation of the current over the time, depending on the data points given by the user.

6.9 DC operation



In emergency light systems with a central battery supply the DC recognition function uses the input voltage to detect if emergency mode is present.

The LED driver then automatically switches to DC mode and dims the light to the defined DC level.

Without DC recognition different and more complex solutions would have to be applied in order to detect emergency mode.

DC recognition is integrated in the device as standard.

No additional commissioning is necessary for activation.



This is a safety-relevant parameter.

The setting is relevant for the dimensioning of the central battery system.

The LED driver is designed to operate on DC voltage and pulsed DC voltage. For a reliable operation, make sure that also in DC emergency operation the LED driver is run within the specified conditions as stated in chapter "4.1 operating window".

Light output level in DC operation: programmable 1 – 100 % (factory default = 15 %, EOF_i = 0.13).

The voltage-dependent input current of Driver incl. LED module is depending on the used load.

The voltage-dependent no-load current of Driver (without or defect LED module) is for:

AC: 21.8 mA (at 230 V, 50 Hz)

DC: 5 – 7 mA (at 275 – 186 V, 0 Hz)

In DC operation dimming mode can be activated.

If Dimming on DC is activated the requirements of the DC recognition function are ignored.

Even if DC is detected, the LED driver continues to behave as in AC mode

- The present dimming level is retained
- An emergency light level defined for the DC recognition function (DC level) is ignored
- Control signals via DALI continue to be executed

If Dimming on DC is activated then emergency mode is not recognised. The device no longer automatically switches to the emergency light level.

6.10 Enhanced power on level (ePOL)



The Enhanced Power On Level parameter defines the power level that is set automatically when power is restored after a power failure.

The Enhanced Power On Level can be set to a fixed value (0 – 100 %) or can recall the memory value.

The memory value is the last value the LED driver was set to before the power failure.

This value applies not only in DALI device operating mode, but also in the device operating mode switchDIM.

6.11 DALI default parameters



In order for all luminaires to react the same for each operation (switching, dimming, scene recall ...), these values must be set the same.

These DALI standard parameters are supported by every DALI-2 device.

6.12 Scenes and groups



Each device can be a member of up to 16 groups.

Also, 16 different scene values can be stored in each device.

6.13 Dimming curve



DALI:

The desired dimming behaviour is selected via two different dimming curves (logarithmic or linear).

The default setting of the dimming behaviour is logarithmic.

6.14 Channel grouping



With this, the number of output channels can be split / grouped differently.

This is important for the control of the device. The physical LED outputs are assigned to different logical units (DALI addresses).

6.15 proportionSWITCH



proportionSWITCH is an extension of switchDIM.

You can call up to 10 predefined intensity levels.

With a short press via a pushbutton on terminal PS, the 10 predefined levels can be called up in succession.

With a long press via a pushbutton on terminal PS, the level is continuously adjusted.

For multi-channel devices, both channels dim in the opposite direction.

A conventional pushbutton can be used to control the system via proportionSWITCH.

Use of pushbutton with indicator lamp is not permitted.

In installations with LED drivers with different dimming level or opposite dimming direction (e.g. after a system extension), all LED drivers can be synchronized to a standard value by a 10 s push.

7. Protective features

7.1 Intelligent temperature guard (ITG)



The Intelligent temperature guard (ITG) function provides effective protection against thermal overloads by slowly reducing the output if a defined internal temperature is exceeded.

The reduction of overtemperatures takes place in small steps every two minutes. As soon as the temperature drops again, the output power is gradually increased every 10 minutes.

On DC operation this function is deactivated to fulfill emergency requirements.

7.2 Intelligent Voltage Guard (IVG)



The Intelligent Voltage Guard (IVG) function warns of possible damage due to overvoltage or undervoltage.

The mains voltage is constantly monitored and if necessary appropriate responses are made:

- If the mains voltage is too low (< 70 V), the LED driver is switched off.
- At a mains voltage between 70 and 140 V, the LED driver switches off and on again on a non-cyclic basis.
- In case of an overvoltage (> 318 V), the LED driver sends feedback via DALI.

7.3 Short-circuit behaviour

In case of a short-circuit at the LED output the LED output is switched off. After restart of the LED driver the output will be activated again. The restart can either be done via mains reset or via interface (DALI, DSI, switchDIM).

7.4 No-load operation

The LED driver will not be damaged in no-load operation. The output will be deactivated and is therefore free of voltage. If a LED load is connected the device has to be restarted before the output will be activated again.

7.5 Overload protection

If the maximum load is exceeded by a defined internal limit, the LED driver turns off the LED output. After restart of the LED driver the output will be activated again.

The restart can either be done via mains reset or via interface (DALI, DSI, switchDIM).

7.6 Insulation between terminals

Insulation	Mains	PE	LED	DALI
Mains	–	basic	double	basic
PE	basic	–	basic	basic
LED	double	basic	–	double
DALI	basic	basic	double	–

basic ... represents basic insulation.

double ... represents double or reinforced insulation.

8. Miscellaneous

8.1 Insulation and electric strength testing of luminaires

Electronic devices can be damaged by high voltage. This has to be considered during the routine testing of the luminaires in production.

According to IEC 60598-1 Annex Q (informative only!) or ENEC 303-Annex A, each luminaire should be submitted to an insulation test with 500 V_{DC} for 1 second. This test voltage should be connected between the interconnected phase and neutral terminals and the earth terminal. The insulation resistance must be at least 2 MΩ.

As an alternative, IEC 60598-1 Annex Q describes a test of the electrical strength with 1500 V_{AC} (or 1.414 x 1500 V_{DC}). To avoid damage to the electronic devices this test must not be conducted.

8.2 Conditions of use and storage

Humidity: 5% up to max. 85%,
not condensed
(max. 56 days/year at 85%)

Storage temperature: -40 °C up to max. +80 °C

The devices have to be acclimatised to the specified temperature range (ta) before they can be operated.

The LED driver is declared as inbuilt LED controlgear, meaning it is intended to be used within a luminaire enclosure.

If the product is used outside a luminaire, the installation must provide suitable protection for people and environment (e.g. in illuminated ceilings).

8.3 Maximum number of switching cycles

All LED driver are tested with 50,000 switching cycles. The actually achieved number of switching cycles is significantly higher.

8.4 Additional information

Additional technical information at www.tridonic.com → Technical Data

Lifetime declarations are informative and represent no warranty claim. No warranty if device was opened.