

Driver LC 35W 48V o4a NF SC EXC

excite series 48 V – dimmable (IP20)

**Product description**

- _ NEW: lumDATA (Luminaire data, Energy reporting and Diagnostics & Maintenance)
- _ Dimmable 48 V constant voltage LED driver for flexible constant voltage strips
- _ Can be either used built-in or independent with clip-on strain-relief
- _ The strain relief is included in both packaging variants. In the single packaging (SP) each Driver has also an individual packaging
- _ one4all interface enables different dimming options
- _ Dimming range 1 to 100 %
- _ No additional external dimmer is needed
- _ Suitable for emergency escape lighting systems acc. to EN 50172
- _ Nominal lifetime up to 100,000 h
- _ 5 years guarantee (conditions at <https://www.tridonic.com/en/int/services/manufacturer-guarantee-conditions>)

Typical applications

- _ Cove lighting, facade accent lighting, ceiling integration

Technical details

- _ 48 V, 35 W
- _ Small cross section
- _ Push terminals for simple wiring

Interfaces

- _ Near field communication (NFC)
- _ one4all (DALI-2, DSI, switchDIM, corridorFUNCTION)
- _ Terminal blocks: 45° push terminals

System solution

- _ Tridonic LLE FLEX 8 mm 48V EXC 600, 1,200, 1,800, 2,500 lm/m
- _ Tridonic LLE FLEX 12 mm 48V EXC 3,000, 4,000 lm/m
- _ Test the function of third party light sources before use at low dimming levels to ensure the dimming function works perfectly

**Website**

<http://www.tridonic.com/28003533>



Linear



High bay



Decorative



Downlights



Spotlights



Free-standing



Area



Floor | Wall



Street

Driver LC 35W 48V o4a NF SC EXC

excite series 48 V – dimmable (IP20)

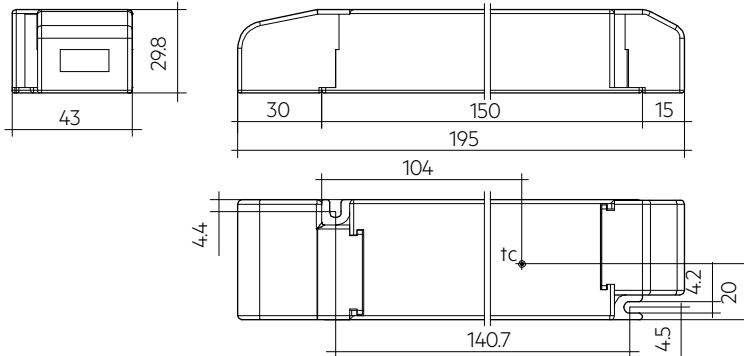
**Ordering data**

Type	Article number	Packaging, carton	Packaging, pallet	Weight per pc.
Multi packaging				
LC 35W 48V one4all NF SC EXC	28003533	10 pc(s).	390 pc(s).	0.137 kg
Single packaging				
LC 35W 48V one4all NF SC EXC SP	28003840	10 pc(s).	390 pc(s).	0.137 kg

Technical data

Rated supply voltage	220 – 240 V
AC voltage range	198 – 264 V
DC voltage range	176 – 280 V
Mains frequency	0 / 50 / 60 Hz
Overvoltage protection	320 V AC, 48 h
Typ. rated current (at 230 V, 50 Hz, full load) ^①	200 mA
Typ. current (220 V, 0 Hz, full load, 15 % dimming level)	35 mA
Leakage current (at 230 V, 50 Hz, full load) ^①	< 700 µA
Max. input power	40 W
Typ. efficiency (at 230 V, 50 Hz, full load)	89 %
λ (at 230 V, 50 Hz, full load) ^①	0.97
Typ. power consumption on stand-by	< 0.2 W
Typ. input current in no-load operation	< 25 mA
Typ. input power in no-load operation	< 0.3 W
In-rush current (peak / duration)	34.3 A / 160 µs
THD (at 230 V, 50 Hz, full load) ^①	< 10 %
Output P _{ST_LM} (at full load)	≤ 1
Output SVM (at full load)	≤ 0.4
Starting time (at 230 V, 50 Hz, full load) ^①	< 0.6 s
Starting time (DC mode)	< 0.4 s
Switchover time (AC/DC)	< 0.2 s
Turn off time (at 230 V, 50 Hz, full load)	< 0.02 s
Output voltage tolerance	± 2 V
Output LF voltage ripple (< 120 Hz)	± 5 %
Max. output voltage (U-OUT)	60 V
PWM frequency	~ 1 kHz
Dimming range	1 – 100 %
Mains surge capability (between L - N)	1 kV
Mains surge capability (between L/N - PE)	2 kV
Type of protection	IP20
Lifetime	up to 100,000 h
Guarantee (conditions at www.tridonic.com)	5 Year(s)
Dimensions L x W x H	195 x 43 x 30 mm

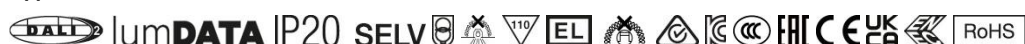
Approval marks

Standards

EN 55015, EN 61000-3-2, EN 61000-3-3, EN 61347-1, EN 61347-2-13, EN 62384, EN 61547, EN 62386-101, EN 62386-102, EN 62386-207 (DALI-2), according to EN 50172, according to EN 60598-2-22

Specific technical data

Type	Load	Output voltage	Output current	Max. output power (at full load)	Typ. power consumption (at full load)	Typ. current consumption	t_c point max.	Ambient temperature t_a
LC 35W 48V one4all NF SC EXC	10 %	48 V	73 mA	3.5 W	5.7 W	41 mA	73 °C	-25 ... +55 °C
LC 35W 48V one4all NF SC EXC	20 %	48 V	147 mA	7.0 W	13.0 W	53 mA	73 °C	-25 ... +55 °C
LC 35W 48V one4all NF SC EXC	30 %	48 V	220 mA	10.5 W	17.0 W	65 mA	73 °C	-25 ... +55 °C
LC 35W 48V one4all NF SC EXC	40 %	48 V	290 mA	14.0 W	21.0 W	79 mA	73 °C	-25 ... +55 °C
LC 35W 48V one4all NF SC EXC	50 %	48 V	365 mA	17.5 W	24.0 W	94 mA	73 °C	-25 ... +55 °C
LC 35W 48V one4all NF SC EXC	60 %	48 V	440 mA	21.0 W	28.0 W	110 mA	73 °C	-25 ... +55 °C
LC 35W 48V one4all NF SC EXC	70 %	48 V	510 mA	24.5 W	32.0 W	125 mA	73 °C	-25 ... +55 °C
LC 35W 48V one4all NF SC EXC	80 %	48 V	585 mA	28.0 W	35.5 W	141 mA	74 °C	-25 ... +55 °C
LC 35W 48V one4all NF SC EXC	90 %	48 V	660 mA	31.5 W	39.0 W	157 mA	73 °C	-25 ... +50 °C
LC 35W 48V one4all NF SC EXC	100 %	48 V	730 mA	35.0 W	9.5 W	173 mA	73 °C	-25 ... +50 °C
LC 35W 48V one4all NF SC EXC SP	10 %	48 V	73 mA	3.5 W	5.7 W	41 mA	73 °C	-25 ... +55 °C
LC 35W 48V one4all NF SC EXC SP	20 %	48 V	147 mA	7.0 W	13.0 W	53 mA	73 °C	-25 ... +55 °C
LC 35W 48V one4all NF SC EXC SP	30 %	48 V	220 mA	10.5 W	17.0 W	65 mA	73 °C	-25 ... +55 °C
LC 35W 48V one4all NF SC EXC SP	40 %	48 V	290 mA	14.0 W	21.0 W	79 mA	73 °C	-25 ... +55 °C
LC 35W 48V one4all NF SC EXC SP	50 %	48 V	365 mA	17.5 W	24.0 W	94 mA	73 °C	-25 ... +55 °C
LC 35W 48V one4all NF SC EXC SP	60 %	48 V	440 mA	21.0 W	28.0 W	110 mA	73 °C	-25 ... +55 °C
LC 35W 48V one4all NF SC EXC SP	70 %	48 V	510 mA	24.5 W	32.0 W	125 mA	73 °C	-25 ... +55 °C
LC 35W 48V one4all NF SC EXC SP	80 %	48 V	585 mA	28.0 W	35.5 W	141 mA	74 °C	-25 ... +55 °C
LC 35W 48V one4all NF SC EXC SP	90 %	48 V	660 mA	31.5 W	39.0 W	157 mA	73 °C	-25 ... +50 °C
LC 35W 48V one4all NF SC EXC SP	100 %	48 V	730 mA	35.0 W	9.5 W	173 mA	73 °C	-25 ... +50 °C

① Valid at 100 % dimming level.

1. Standards

EN 55015
 EN 61000-3-2
 EN 61000-3-3
 EN 61347-1
 EN 61347-2-13
 EN 62384
 EN 61547
 EN 62386-101 (DALI-2)
 EN 62386-102 (DALI-2)
 EN 62386-207 (DALI-2, including part 251, 252, 253)
 According to EN 50172 for use in central battery systems
 According to EN 60598-2-22 suitable for emergency lighting installations

2. Thermal details and lifetime

2.1 Expected lifetime

Expected lifetime						
Type	Output load	ta	40 °C	45 °C	50 °C	55 °C
	< 25 W	tc	60 °C	65 °C	68 °C	73 °C
		Lifetime	>100,000 h	>100,000 h	80,000 h	60,000 h
LC 35W 48V one4all NF SC EXC	25 – 30 W	tc	60 °C	66 °C	70 °C	74 °C
		Lifetime	>100,000 h	90,000 h	65,000 h	55,000 h
	30 – 35 W	tc	61 °C	66 °C	73 °C	–
		Lifetime	>100,000 h	80,000 h	50,000 h	–

The LED control gear is designed for a lifetime stated above under reference conditions and with a failure probability of less than 10 %.

The relation of tc to ta temperature depends also on the luminaire design.

If the measured tc temperature is approx. 5 K below tc max., ta temperature should be checked and eventually critical components (e.g. ELCAP) measured. Detailed information on request.

3. Installation / wiring

3.1 Circuit diagram

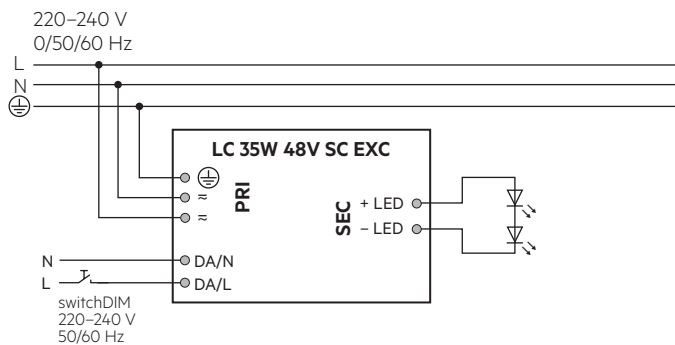
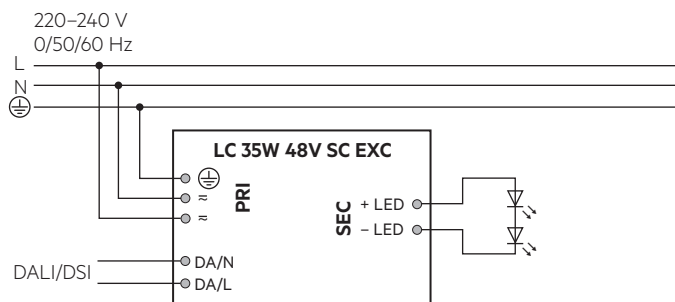

 Recommendation to check glowing at standby in combination with class I luminaires.

3.2 Wiring type and cross section

Mains supply wires

For wiring use stranded wire with ferrules or solid wire from 0.2 – 1.5 mm².
 For perfect function of the push-wire terminals the strip length should be 8.5 – 9.5 mm.
 Use one wire for each terminal connector only.

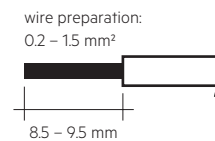

Secondary wires (LED module)

For wiring use stranded wire with ferrules or solid wire from 0.2 – 1.5 mm² (24AWG – 16AWG).
 For perfect function of the push-wire terminals the strip length should be 8.5 – 9.5 mm.
 Use one wire for each terminal connector only.

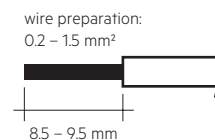

Secondary strain relief for cables with bigger cable sheath

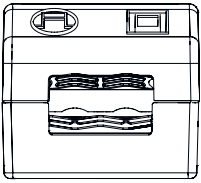

Secondary strain relief for cable with smaller cable sheath

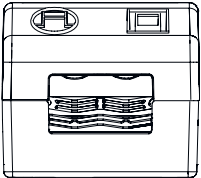

3.3 Loose wiring

Mains supply wires

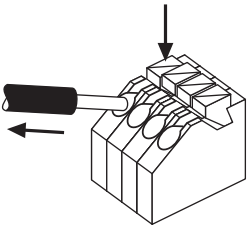

Release of the wiring

Press down the "push button" and remove the cable from front.

Secondary wires (LED module)

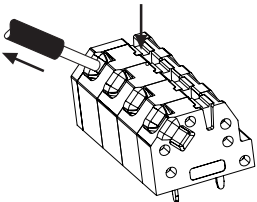

3.4 Fixing conditions when using as independent Driver with Clip-On

Dry, acidfree, oilfree, fatfree. It is not allowed to exceed the maximum ambient temperature (t_a) stated on the device. Minimum distances stated below are recommendations and depend on the actual luminaire. Is not suitable for fixing in corner.

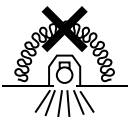
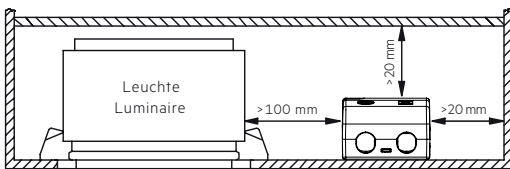

Device not suitable for covering with thermally insulating material according to IEC 60598-1 Ed.9

3.5 Wiring guidelines

- Run the secondary lines separately from the mains connections and lines to achieve good EMC performance.
- The max. secondary cable (LED module) length is 2 m (4 m circuit).
- For good EMC performance, keep the LED wiring as short as possible.
- To comply with the EMC regulations run the secondary wires (LED module) in parallel.
- Secondary switching is not permitted.
- The LED driver has no inverse-polarity protection on the secondary side. Wrong polarity can damage LED modules with no inverse-polarity protection.
- Wrong wiring of the LED driver can lead to malfunction or irreparable damage.
- To avoid damage of the Driver, the wiring must be protected against short circuits to earth (sharp edged metal parts, metal cable clips, louver, etc.).

3.6 Hot plug-in

Hot plug-in is not supported due to residual output voltage of > 0 V. When connecting an LED load, restart the device to activate the LED output. This can be done via mains reset or via interface (DALI, DSI, switchDIM).

3.7 Earth connection

The earth connection is conducted as protection earth (PE). The LED driver can be earthed via earth terminal. If the LED driver will be earthed, protection earth (PE) has to be used. There is no earth connection required for the functionality of the LED driver. Earth connection is recommended to improve following behaviour:

- Electromagnetic interferences (EMI)
- LED glowing at standby
- Transmission of mains transients to the LED output

In general it is recommended to earth the LED driver if the LED module is mounted on earthed luminaire parts respectively heat sinks and thereby representing a high capacity against earth.

4. Electrical values

4.1 Efficiency vs. load

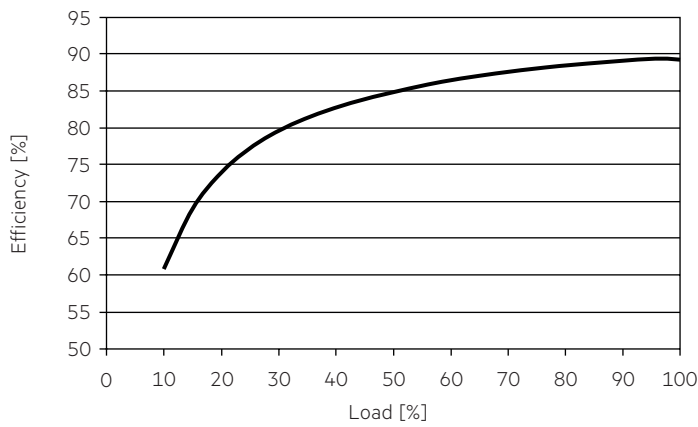

4.4 Input current vs. Load

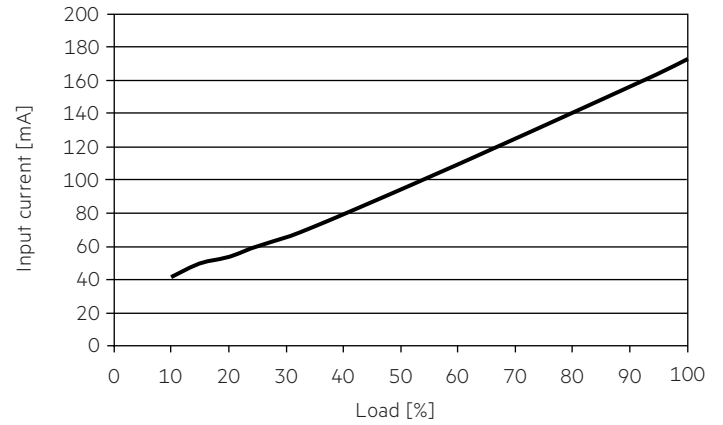

4.2 Power factor vs. Load

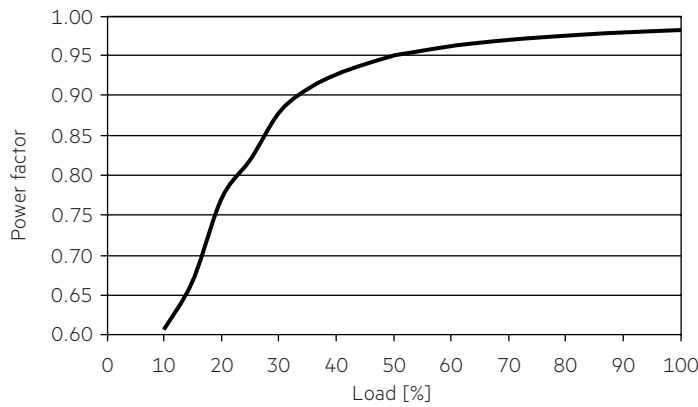

4.5 THD vs. Load

THD without harmonic < 5 mA (0.6 %) of the input current:

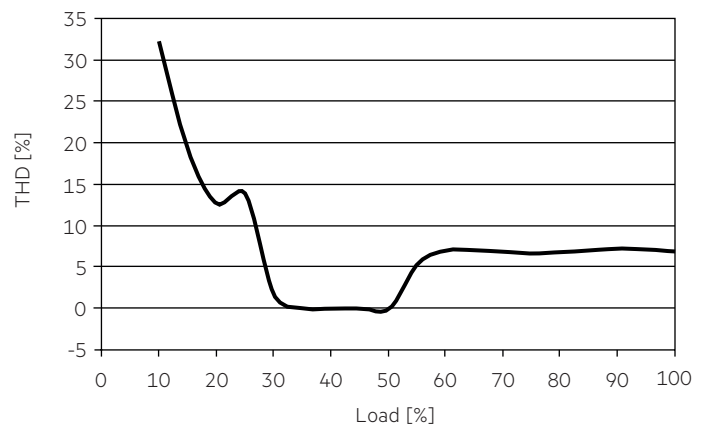

4.3 Input power vs. Load

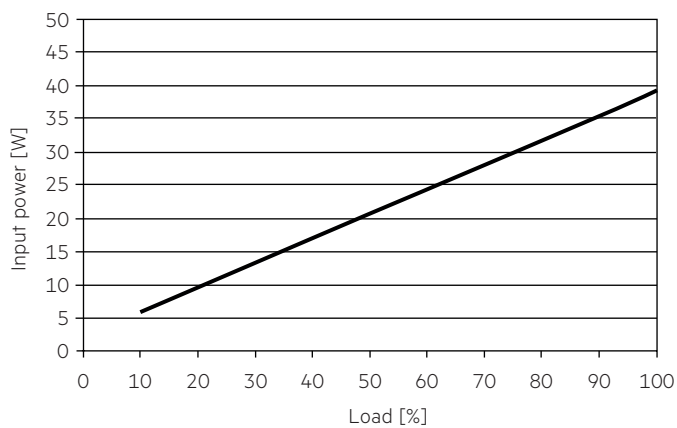

4.6 Maximum loading of automatic circuit breakers in relation to inrush current

Automatic circuit breaker type	C10	C13	C16	C20	B10	B13	B16	B20	Inrush current	
Installation Ø	1.5 mm ²	1.5 mm ²	2.5 mm ²	2.5 mm ²	1.5 mm ²	1.5 mm ²	2.5 mm ²	2.5 mm ²	I_{max}	time
LC 35W 48V one4all NF SC EXC	32	44	56	72	16	22	28	36	34.3 A	160 µs

These are max. values calculated out of inrush current! Please consider not to exceed the maximum rated continuous current of the circuit breaker.

Calculation uses typical values from ABB series S200 as a reference.

Actual values may differ due to used circuit breaker types and installation environment.

4.7 Harmonic distortion in the mains supply (at 230 V / 50 Hz and full load) in %

	THD	3.	5.	7.	9.	11.
LC 35W 48V one4all NF SC EXC	7	4	4	3	2	2

4.8 Dimming

Dimming range 1% to 100%

Digital control with:

- DSI signal: 8 bit Manchester Code
Speed 1% to 100% in 1.4 s
- DALI signal: 16 bit Manchester Code
Speed 1% to 100% in 0.2 s
Programmable parameter:
Minimum dimming level
Maximum dimming level
Default minimum = 1%
Programmable range $1\% \leq \text{MIN} \leq 100\%$
Default maximum = 100%
Programmable range $100\% \geq \text{MAX} \geq 1\%$

Dimming is realized by PWM frequency.

4.9 Dimming characteristics

Digital dimming value

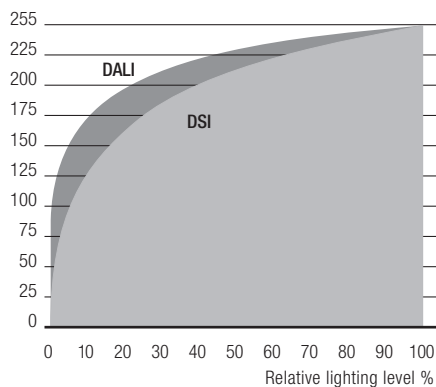

Dimming characteristics as seen by the human eye

5. Software / Programming / Interfaces

5.1 Software / programming

With appropriate software and interface different functions can be activated and various parameters can be configured in the LED driver. The Driver supports the following software and interfaces:

Software / hardware for configuration:

- companionSUITE (deviceGENERATOR, deviceCONFIGURATOR, deviceANALYSER)
- masterCONFIGURATOR

Interfaces for data transfer:

- NFC
- Control input DALI

5.2 Nearfield communication (NFC)

The NFC Interface allows wireless communication with the LED driver. This interface offers the option to write configuration and to read configuration, errors and events with the companionSUITE. A correct communication between the LED driver and the NFC antenna can only be guaranteed if the antenna is placed directly on the Driver. Any material placed between the LED driver and the NFC antenna can cause a deterioration of the communication quality. After programming the device via NFC power up the device one time for one second till the deviceANALYSER can read out the parameters. We recommend the use of following NFC antenna: www.tridonic.com/nfc-readers

NFC is complied with ISO/IEC 15963 standard.

Changing parameters via NFC shall be done by qualified engineers only.

5.3 Control input DALI

The control input is non-polar for digital control signals (DALI). The control signal is not SELV. The control cable has to be installed in accordance to the requirements of low voltage installations.

Digital control with:

- DALI signal: 16 bit
- DSI signal: 8 bit

6. Functions

 companionSUITE:





























































DALI-USB, NFC

The companionSUITE with deviceGENERATOR, deviceCONFIGURATOR and deviceANALYSER is available via our WEB page:
<https://www.tridonic.com/com/en/products/companionsuite.asp>

 masterCONFIGURATOR:

DALI-USB

The masterCONFIGURATOR is available via our WEB page:
<https://www.tridonic.com/com/en/software-masterconfigurator.asp>

Icon	Function	NFC	DALI-2
	OEM Identification		 
	OEM GTIN		 
	Luminaire data		 -
	Device operating mode		 
	switchDIM		 
	corridorFUNCTION		 
	Constant light output (CLO)		 
	DC level		 
	Enhanced power on level (ePOL)		 
	DALI default parameters		 
	Scenes and groups		 
	fade2zero		 -
	Power-up fading		 -
	Intelligent voltage guard (IVG)		 
	Dimming curve		 
	deviceKEY		 

6.1 OEM Identification

The OEM (Original Equipment Manufacturer) can set his own identification number.

DALI Part 251: Memory bank 1 extension.

6.2 OEM GTIN

The Original Equipment Manufacturer (OEM) can set his own Global Trade Item Number (GTIN).

DALI Part 251: Memory bank 1 extension.

6.3 Luminaire data

This function provides the asset management with accurate data about the luminaire.

DALI Part 251: Memory bank 1 extension.

6.4 Device operating mode

A Tridonic Driver supports several control signals.

These control signals are automatically detected and the mode is adapted.

If only one special device mode is required, this mode can be selected.

“Automatic detection” is the default setting.

6.5 switchDIM

Integrated switchDIM function allows a direct connection of a pushbutton for dimming and switching.

Brief push (< 0.6 s) switches LED driver ON and OFF. The dimm level is saved at power-down and restored at power-up. When the pushbutton is held, LED modules are dimmed. After repush the LED modules are dimmed in the opposite direction.

In installations with LED drivers with different dimming levels or opposite dimming directions (e.g. after a system extension), all LED drivers can be synchronized to 50 % dimming level by a 10 s push.

Use of pushbutton with indicator lamp is not permitted.

switchDIM 2

Version 2 has now the possibility to define different fade times used for short button press events. So the fade time to set memory level (if wake-up from standby) as well as the fade time to switch off can now be configured.

6.6 corridorFUNCTION

With the corridorFUNCTION and a commercially available motion detector, it is easy to adapt the lighting in one area to its use.

That is, when the area is entered by a person, the lighting dims instantly to the desired brightness and is available in full strength.

After the area is left by the person, the brightness dims slowly to a smaller value or switches off completely.

The individual parameters of the desired profile, such as brightness values or delay times, can be adjusted flexibly and individually.

6.7 Constant Light Output (CLO)

With this function the light output of the LED module can be kept equal over the lifetime.

The light output of an LED module reduces over the course of its lifetime.

The Constant Light Output (CLO) function compensates for this natural decline by constantly increasing the output current of the LED driver throughout its lifetime.

CLO shall be achieved by limitation of the LED current at the commissioning of the LED driver and providing a linear interpolation of the current over the time, depending on the data points given by the user.

6.8 DC operation



In emergency light systems with a central battery supply the DC recognition function uses the input voltage to detect if emergency mode is present.

The LED driver then automatically switches to DC mode and dims the light to the defined DC level.

Without DC recognition different and more complex solutions would have to be applied in order to detect emergency mode.

DC recognition is integrated in the device as standard.

No additional commissioning is necessary for activation.



This is a safety-relevant parameter.

The setting is relevant for the dimensioning of the central battery system.

The LED driver is designed to operate on DC voltage and pulsed DC voltage. For a reliable operation, make sure that also in DC emergency operation the LED driver is run within the specified power range.

Light output level in DC operation: programmable 1 – 100 % (factory default = 15 %, EOFu = 0.13).

The voltage-dependent input current of Driver incl. LED module is depending on the used load.

The voltage-dependent no-load current of Driver (without or defect LED module) is for:

AC: < 28 mA

DC: < 1.15 mA

In DC operation dimming mode can be activated.

If Dimming on DC is activated the requirements of the DC recognition function are ignored.

Even if DC is detected, the LED driver continues to behave as in AC mode

- The present dimming level is retained
- An emergency light level defined for the DC recognition function (DC level) is ignored
- Control signals via DALI continue to be executed

If Dimming on DC is activated then emergency mode is not recognised.

The device no longer automatically switches to the emergency light level.

6.9 Enhanced power on level (ePOL)



The Enhanced Power On Level parameter defines the power level that is set automatically when power is restored after a power failure.

The Enhanced Power On Level can be set to a fixed value (0 – 100 %) or can recall the memory value.

The memory value is the last value the LED driver was set to before the power failure.

This value applies not only in DALI device operating mode, but also in the device operating mode switchDIM.

6.10 DALI default parameters



In order for all luminaires to react the same for each operation (switching, dimming, scene recall ...), these values must be set the same.

These DALI standard parameters are supported by every DALI-2 device.

6.11 Scenes and groups



Each device can be a member of up to 16 groups.

Also, 16 different scene values can be stored in each device.

6.12 fade2zero



When the Driver is switched off, fade2zero allows a smooth dimming down to almost zero.

Activate the fade2zero function when programming with companionSUITE and set a DALI fade time. fade2zero only works if the minimum dimming level of the Driver is the default value.

The device then dims to far below the limit of its working window (dimming range).

This function is deactivated by default.

6.13 Power-up fading



The power-up function offers the opportunity to modify the on behavior.

The time for fading on can be adjusted in a range of 0.2 to 16 seconds.

According to this value, the device dims from 0 % up to the power-on level.

By factory default no fading time is set (= 0 seconds).

6.14 Dimming curve



DALI:

The desired dimming behaviour is selected via two different dimming curves (logarithmic or linear).

The default setting of the dimming behaviour is logarithmic.

6.15 deviceKEY



This function enables a password protection for device settings to prevent unauthorized access or changes.

7. Protective features

7.1 Intelligent temperature guard (ITG)



The Intelligent temperature guard (ITG) function provides effective protection against thermal overloads by slowly reducing the output if a defined internal temperature is exceeded.

The reduction of overtemperatures takes place in small steps every two minutes. As soon as the temperature drops again, the output power is gradually increased every 10 minutes.

On DC operation this function is deactivated to fulfill emergency requirements.

7.2 Intelligent Voltage Guard (IVG)



The Intelligent Voltage Guard (IVG) function warns of possible damage due to overvoltage or undervoltage.

The mains voltage is constantly monitored and if necessary appropriate responses are made:

- If the mains voltage is too low (< 70 V), the LED driver is switched off.
- At a mains voltage between 70 and 140 V, the LED driver switches off and on again on a non-cyclic basis.
- In case of an overvoltage (> 318 V), the LED driver sends feedback via DALI.

7.3 Short-circuit behaviour

In case of a short-circuit at the LED output the LED output is switched off. After restart of the LED driver the output will be activated again. The restart can either be done via mains reset or via interface (DALI, DSI, switchDIM, ready2mains)

7.4 No-load operation

The LED driver will not be damaged in no-load operation. The output will be deactivated and is therefore free of voltage. If a LED load is connected the device has to be restarted before the output will be activated again.

7.5 Overload protection

If the maximum load is exceeded by a defined internal limit, the LED driver turns off the LED output. After restart of the LED driver the output will be activated again.

The restart can either be done via mains reset or via interface (DALI, DSI, switchDIM, ready2mains).

7.6 Insulation between terminals

Insulation	Mains	PE	LED	DALI
Mains	–	basic	double	basic
PE	basic	–	basic	basic
LED	double	basic	–	double
DALI	basic	basic	double	–

basic ... represents basic insulation.

double ... represents double or reinforced insulation.

7. Miscellaneous

7.1 Insulation and electric strength testing of luminaires

Electronic devices can be damaged by high voltage. This has to be considered during the routine testing of the luminaires in production.

According to IEC 60598-1 Annex Q (informative only!) or ENEC 303-Annex A, each luminaire should be submitted to an insulation test with 500 V_{DC} for 1 second. This test voltage should be connected between the interconnected phase and neutral terminals and the earth terminal. The insulation resistance must be at least 2 MΩ.

As an alternative, IEC 60598-1 Annex Q describes a test of the electrical strength with 1500 V_{AC} (or 1.414 x 1500 V_{DC}). To avoid damage to the electronic devices this test must not be conducted.

7.2 Conditions of use and storage

Humidity: 5% up to max. 85%,
not condensed
(max. 56 days/year at 85%)

Storage temperature: -40 °C up to max. +80 °C

The devices have to be acclimatised to the specified temperature range (ta) before they can be operated.

The LED driver is declared as inbuilt LED controlgear, meaning it is intended to be used within a luminaire enclosure.

If the product is used outside a luminaire, the installation must provide suitable protection for people and environment (e.g. in illuminated ceilings).

7.3 Maximum number of switching cycles

All LED driver are tested with 50,000 switching cycles.

The actually achieved number of switching cycles is significantly higher.

7.4 Additional information

Additional technical information at www.tridonic.com → Technical Data

Lifetime declarations are informative and represent no warranty claim.

No warranty if device was opened.