

## FXEXB-RK RECESSING EXIT BLADE KIT

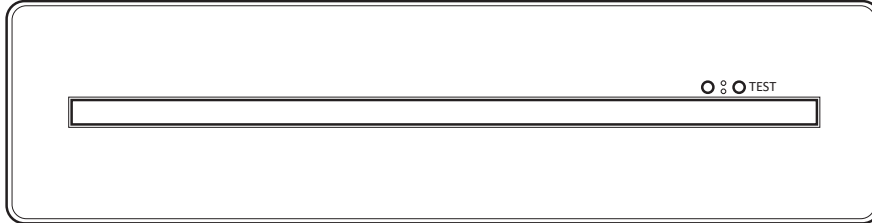

### Technical Data

Model Variant

FXEXB-RK

Dimensions

378 x 94 x 7mm

### Installation Guide

#### 1 Release Front Trim

Release the two snap clips on one end of the front trim.

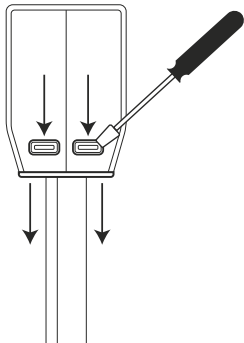

#### 2 Unclip Front Trim

Continue to remove the front trim along the length of the exit blade body.

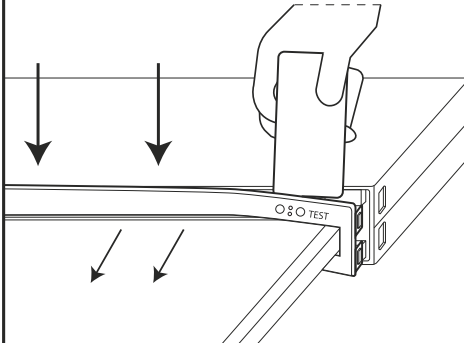

#### 3 Remove Front Trim

Slide the front trim down and off the exit blade.

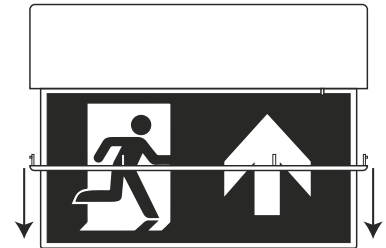

#### 4 Position Recess Plate

Put the exit blade through the recessing kit.

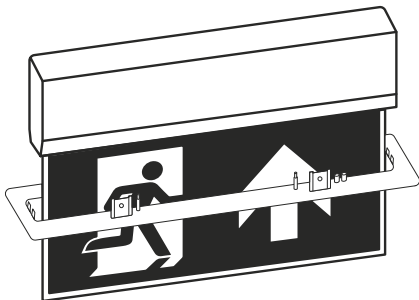

#### 5 Align Test Button

Align the test button hole with the test button on the exit blade. Ensure they are aligned before proceeding to the next step.

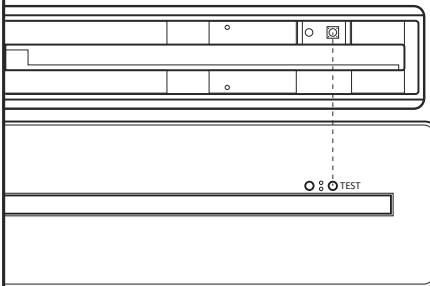

#### 6 Insert Recess Pins

Insert 4 pins on the recess plate till they are flushed with the main housing.

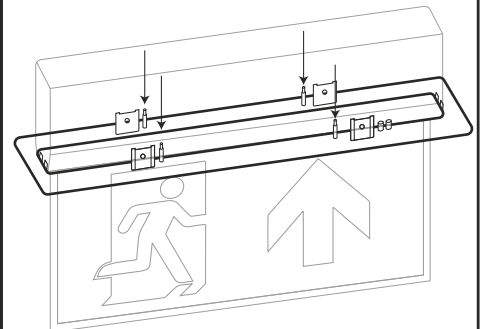

**FXEXB-RK RECESSING EXIT BLADE KIT**

**Installation Guide**

**7 Secure Snap Clips**

Make sure the 4 snap clips on the recess plate are secured with the main housing.

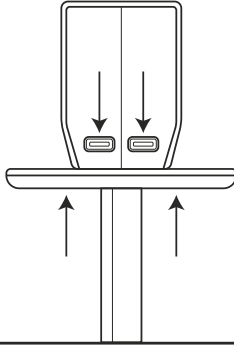

**8 Insert Springs**

Insert 4 metal springs before installing luminaire.

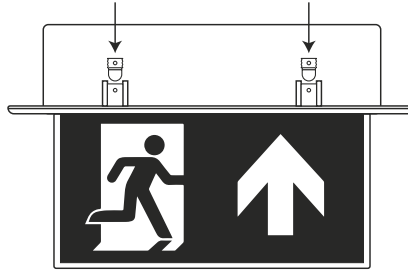

**9 Install Luminaire**

Feed the body of the luminaire through the mounting hole. The springs will secure kit in place automatically.

