

Module SLE ADV8

Modules SLE advanced



LES17 with housing



LES21 with housing

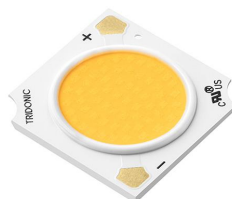

LES13

Product description

- _ For spotlights and downlights
- _ TIM variants for easy and fast assembly
- _ For operating with SELV Driver suitable
- _ Excellent thermal management by COB technology
- _ Uniform radiation with Dam&Fill technology
- _ Integrated LED module
- _ Cooling required
- _ Flexible operating mode
- _ Long lifetime: 60,000 hours
- _ 5 years guarantee (conditions at <https://www.tridonic.com/en/int/services/manufacturer-guarantee-conditions>)

Optical properties

- _ Colour temperatures 2,700, 3,000, 3,500 and 4,000 K
- _ Useful luminous flux 7,725 lm at Irated and tp = 25 °C
- _ Efficacy of the LED module 192 lm/W at Irated and tp = 25 °C
- _ High colour rendering index CRI > 80
- _ Small colour tolerance (MacAdam 3) ^①

Mechanical properties

- _ Module dimension LES09, LES13, LES15, LES17 and LES21
- _ Housing with Snap-On feature for easy reflector mounting
- _ 50 mm housing with 35 mm mounting hole distance acc. to Zhaga
- _ Fixing holes for M3 screws

System solution

- _ Integrate compatible partner products into your final system solution: <https://www.tridonic.com/en/int/products/accessories#partner>
- _ Combine Tridonic's LED modules and dimmable drivers to achieve an outstanding system efficacy (configuration possible via <https://setbuilder.tridonic.com/>)

^① Integral measurement over the complete module.

Website

<http://www.tridonic.com/28004543>

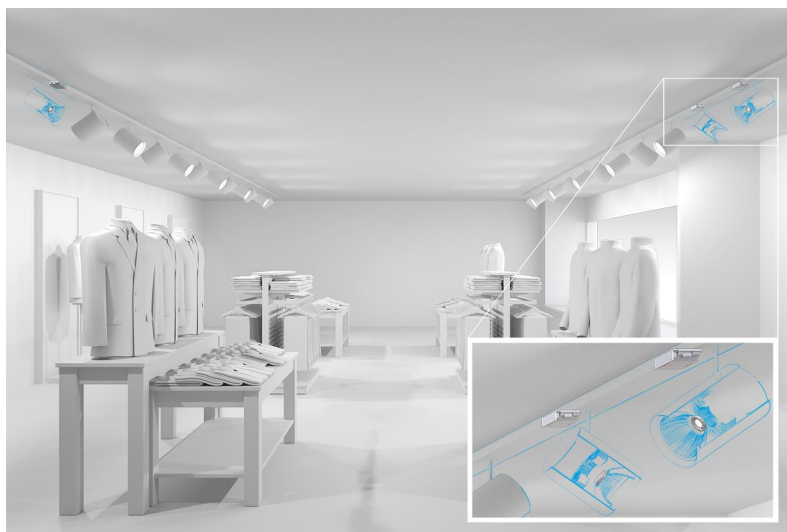

Linear



High bay



Decorative



Downlights



Spotlights



Free-standing



Area



Floor | Wall



Street

Module SLE ADV8

Modules SLE advanced

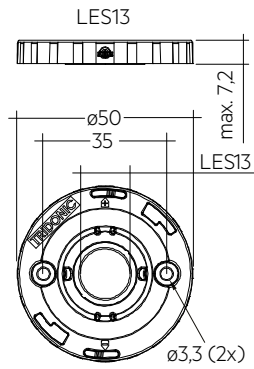

Dimensions in mm, *optical LES

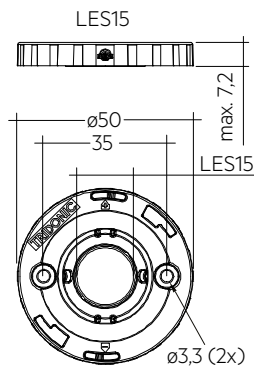

Dimensions in mm, *optical LES

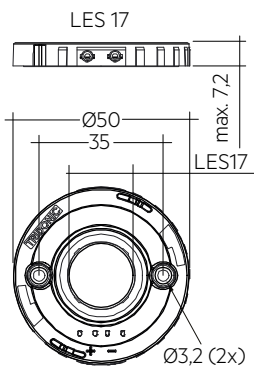

Dimensions in mm, *optical LES

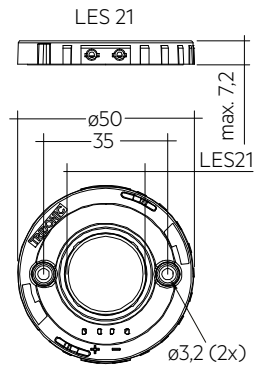

Dimensions in mm, *optical LES

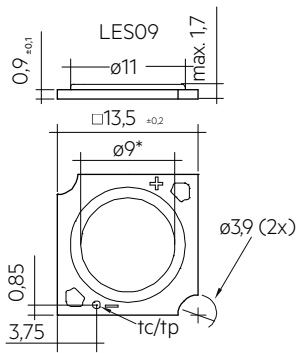

Dimensions in mm, *optical LES

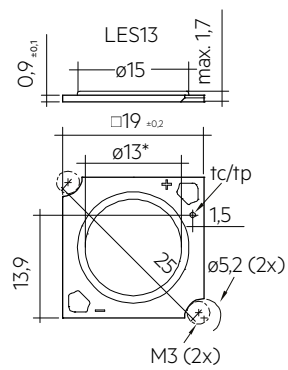

Dimensions in mm, *optical LES

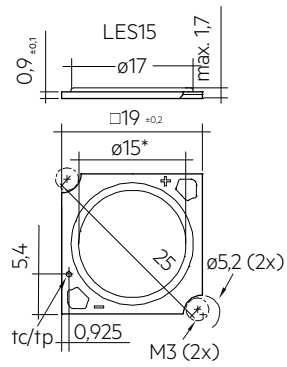

Dimensions in mm, *optical LES

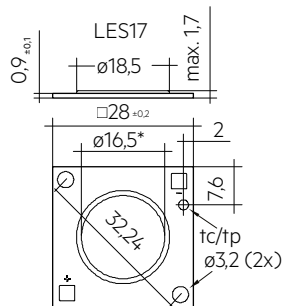

Dimensions in mm, *optical LES

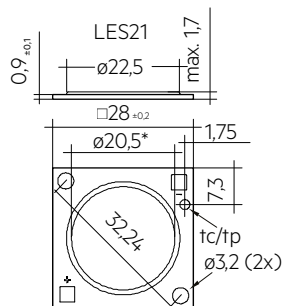

Dimensions in mm, *optical LES

Ordering data

Type	Article number	Colour temperature	Colour rendering index CRI	Packaging, carton	Weight per pc.
SLE 09mm 800lm 830 R ADV8	28004543	3,000 K	>80	20 pc(s).	0.001 kg
SLE 09mm 800lm 840 R ADV8	28004544	4,000 K	>80	20 pc(s).	0.001 kg
SLE 09mm 1200lm 830 R ADV8	28004549	3,000 K	>80	20 pc(s).	0.001 kg
SLE 09mm 1200lm 840 R ADV8	28004550	4,000 K	>80	20 pc(s).	0.001 kg
SLE 13mm 3000lm 827 R ADV8	28004562	2,700 K	>80	20 pc(s).	0.001 kg
SLE 13mm 3000lm 830 R ADV8	28004563	3,000 K	>80	20 pc(s).	0.001 kg
SLE 13mm 3000lm 835 R ADV8	28004564	3,500 K	>80	20 pc(s).	0.001 kg
SLE 13mm 3000lm 840 R ADV8	28004565	4,000 K	>80	20 pc(s).	0.001 kg
SLE 13mm 3000lm 830 H ADV8	28004570	3,000 K	>80	5 pc(s).	0.001 kg
SLE 13mm 3000lm 840 H ADV8	28004571	4,000 K	>80	5 pc(s).	0.001 kg
SLE 15mm 4000lm 827 R ADV8	28004527	2,700 K	>80	20 pc(s).	0.001 kg
SLE 15mm 4000lm 830 R ADV8	28004528	3,000 K	>80	20 pc(s).	0.001 kg
SLE 15mm 4000lm 835 R ADV8	28004529	3,500 K	>80	20 pc(s).	0.001 kg
SLE 15mm 4000lm 840 R ADV8	28004530	4,000 K	>80	20 pc(s).	0.001 kg
SLE 15mm 4000lm 830 H ADV8	28004519	3,000 K	>80	5 pc(s).	0.001 kg
SLE 15mm 4000lm 840 H ADV8	28004520	4,000 K	>80	5 pc(s).	0.001 kg
SLE 15mm 4000lm 830 H ADV8 T	28004523	3,000 K	>80	5 pc(s).	0.001 kg
SLE 15mm 4000lm 840 H ADV8 T	28004524	4,000 K	>80	5 pc(s).	0.001 kg
SLE 17mm 5000lm 827 R ADV8	28004587	2,700 K	>80	10 pc(s).	0.002 kg
SLE 17mm 5000lm 830 R ADV8	28004588	3,000 K	>80	10 pc(s).	0.002 kg
SLE 17mm 5000lm 835 R ADV8	28004589	3,500 K	>80	10 pc(s).	0.002 kg
SLE 17mm 5000lm 840 R ADV8	28004590	4,000 K	>80	10 pc(s).	0.002 kg
SLE 17mm 5000lm 827 H ADV8	28004574	2,700 K	>80	5 pc(s).	0.002 kg
SLE 17mm 5000lm 830 H ADV8	28004575	3,000 K	>80	5 pc(s).	0.002 kg
SLE 17mm 5000lm 835 H ADV8	28004576	3,500 K	>80	5 pc(s).	0.002 kg
SLE 17mm 5000lm 840 H ADV8	28004577	4,000 K	>80	5 pc(s).	0.002 kg
SLE 17mm 5000lm 830 H ADV8 T	28004582	3,000 K	>80	5 pc(s).	0.003 kg
SLE 17mm 5000lm 840 H ADV8 T	28004583	4,000 K	>80	5 pc(s).	0.003 kg
SLE 21mm 6000lm 827 R ADV8	28004606	2,700 K	>80	10 pc(s).	0.002 kg
SLE 21mm 6000lm 830 R ADV8	28004607	3,000 K	>80	10 pc(s).	0.002 kg
SLE 21mm 6000lm 835 R ADV8	28004608	3,500 K	>80	10 pc(s).	0.002 kg
SLE 21mm 6000lm 840 R ADV8	28004611	4,000 K	>80	10 pc(s).	0.002 kg
SLE 21mm 6000lm 827 H ADV8	28004595	2,700 K	>80	5 pc(s).	0.002 kg
SLE 21mm 6000lm 830 H ADV8	28004596	3,000 K	>80	5 pc(s).	0.002 kg
SLE 21mm 6000lm 840 H ADV8	28004597	4,000 K	>80	5 pc(s).	0.002 kg
SLE 21mm 6000lm 830 H ADV8 T	28004602	3,000 K	>80	5 pc(s).	0.003 kg
SLE 21mm 6000lm 840 H ADV8 T	28004603	4,000 K	>80	5 pc(s).	0.003 kg

Technical data

Beam characteristic with housing	117°
Beam characteristic without housing	360°
Ambient temperature t_a	-30 ... +80 °C
t_p rated	65 °C
t_c	105 °C
I _{rated} for LES09	350 mA
I _{rated} for LES13	500 mA
I _{rated} for LES15	800 mA
I _{rated} for LES17	900 mA
I _{rated} for LES21	1,200 mA
I _{max} for LES09 800 lm	500 mA
I _{max} for LES09 1,200 lm	540 mA
I _{max} for LES13	1,000 mA
I _{max} for LES15	1,120 mA
I _{max} for LES17	1,300 mA
I _{max} for LES21	1,930 mA
Max. perm. LF current ripple for LES09 800 lm	550 mA
Max. perm. LF current ripple for LES09 1,200 lm	594 mA
Max. permissible LF current ripple for LES13	1,100 mA
Max. permissible LF current ripple for LES15	1,232 mA
Max. permissible LF current ripple for LES17	1,430 mA
Max. permissible LF current ripple for LES21	2,156 mA
Max. perm. peak current for LES09 800 lm	600 mA / max. 8 ms
Max. perm. peak current for LES09 1,200lm	640 mA / max. 8 ms
Max. permissible peak current for LES13	1,200 mA / max. 8 ms
Max. permissible peak current for LES15	1,340 mA / max. 8 ms
Max. permissible peak current for LES17	1,560 mA / max. 8 ms
Max. permissible peak current for LES21	2,350 mA / max. 8 ms
Max. working voltage for insulation SELV ®	60 V
Insulation test voltage	0.5 kV
Colour tolerance	3 SDCM
ESD classification	Severity level 4
Risk group (IEC 62471) for LES09 800lm 3000K	RG1
Risk group (IEC 62471) for LES09 800lm 4000K (at I _{max})	RG2 (E _{thr} = 1808 lx, RG1 at d ≥ 730 mm)
Risk group (IEC 62471) for LES09 800lm 4000K (at I ≤ 350mA)	RG2 (E _{thr} = 1808 lx, RG1 at d ≥ 620 mm)
Risk group (IEC 62471) for LES09 1,200lm 3000K	RG1
Risk group (IEC 62471) for LES09 1,200lm 4000K (at I _{max})	RG2 (E _{thr} = 1808 lx, RG1 at d ≥ 770 mm)
Risk group (IEC 62471) for LES09 1,200lm 4000K (at I ≤ 350mA)	RG2 (E _{thr} = 1808 lx, RG1 at d ≥ 620 mm)
Risk group (EN 62471:2008) for LES13	RG1
Risk group (IEC 62471) for LES15	RG1
Risk group (IEC 62471) for LES17	RG1
Risk group (IEC 62471) for LES21	RG1
Classification acc. to IEC 62031	Built-in
Type of protection	IP00
Lumen maintenance L70B50	60,000 h
Guarantee (conditions at www.tridonic.com)	5 Year(s)

Approval marks**Standards**

EN 62031, EN 62471, IEC 62717, IEC 61000-4-2, UL 8750

Specific technical data

Type [®]	Article number	Photometric code	Useful luminous flux at tp = 25 °C [®]	Expected luminous flux at tp rated [®]	Typ. forward current	Min. forward voltage at tp rated	Max. forward voltage at tp = 25 °C	Power consumption on Pon at tp = 25 °C	Efficacy of the module at tp = 25 °C	Expected efficacy of the module at tp rated	Colour rendering index: CRI
SLE 09mm 800lm – Operating mode HE at 250 mA											
SLE 09mm 800lm 830 R ADV8	28004543	830/359	-	1,317 lm	250 mA	31.1 V	37.1 V	-	-	156 lm/W	>80
SLE 09mm 800lm 840 R ADV8	28004544	840/359	-	1,394 lm	250 mA	31.1 V	37.1 V	-	-	165 lm/W	>80
SLE 09mm 800lm – Operating mode NM at 350 mA											
SLE 09mm 800lm 830 R ADV8	28004543	830/359	1,993 lm	1,848 lm	350 mA	32.2 V	38.5 V	12.5 W	161 lm/W	151 lm/W	>80
SLE 09mm 800lm 840 R ADV8	28004544	840/359	2,092 lm	1,925 lm	350 mA	32.2 V	38.5 V	12.5 W	168 lm/W	157 lm/W	>80
SLE 09mm 800lm – Operating mode HO at 450 mA											
SLE 09mm 800lm 830 R ADV8	28004543	830/359	-	2,243 lm	450 mA	33.0 V	39.2 V	-	-	140 lm/W	>80
SLE 09mm 800lm 840 R ADV8	28004544	840/359	-	2,385 lm	450 mA	33.0 V	39.2 V	-	-	148 lm/W	>80
SLE 09mm 1200lm – Operating mode HE at 250 mA											
SLE 09mm 1200lm 830 R ADV8	28004549	830/359	-	1,368 lm	250 mA	30.3 V	36.0 V	-	-	166 lm/W	>80
SLE 09mm 1200lm 840 R ADV8	28004550	840/359	-	1,429 lm	250 mA	30.3 V	36.0 V	-	-	174 lm/W	>80
SLE 09mm 1200lm – Operating mode NM at 350 mA											
SLE 09mm 1200lm 830 R ADV8	28004549	830/359	1,999 lm	1,879 lm	350 mA	30.9 V	36.8 V	11.9 W	170 lm/W	160 lm/W	>80
SLE 09mm 1200lm 840 R ADV8	28004550	840/359	2,133 lm	1,986 lm	350 mA	30.9 V	36.8 V	11.9 W	180 lm/W	169 lm/W	>80
SLE 09mm 1200lm – Operating mode HO at 500 mA											
SLE 09mm 1200lm 830 R ADV8	28004549	830/359	-	2,576 lm	500 mA	31.9 V	37.9 V	-	-	149 lm/W	>80
SLE 09mm 1200lm 840 R ADV8	28004550	840/359	-	2,669 lm	500 mA	31.9 V	37.9 V	-	-	154 lm/W	>80
SLE 13mm 3000lm – Operating mode HE at 350 mA											
SLE 13mm 3000lm 827 R ADV8	28004562	827/359	-	1,881 lm	350 mA	30.0 V	35.8 V	-	-	165 lm/W	>80
SLE 13mm 3000lm 830 R ADV8	28004563	830/359	-	1,964 lm	350 mA	30.0 V	35.8 V	-	-	172 lm/W	>80
SLE 13mm 3000lm 835 R ADV8	28004564	835/359	-	2,045 lm	350 mA	30.0 V	35.8 V	-	-	179 lm/W	>80
SLE 13mm 3000lm 840 R ADV8	28004565	840/359	-	2,075 lm	350 mA	30.0 V	35.8 V	-	-	182 lm/W	>80
SLE 13mm 3000lm 830 H ADV8	28004570	830/359	-	1,964 lm	350 mA	30.0 V	35.8 V	-	-	172 lm/W	>80
SLE 13mm 3000lm 840 H ADV8	28004571	840/359	-	2,075 lm	350 mA	30.0 V	35.8 V	-	-	182 lm/W	>80
SLE 13mm 3000lm – Operating mode NM at 500 mA											
SLE 13mm 3000lm 827 R ADV8	28004562	827/359	2,924 lm	2,714 lm	500 mA	30.4 V	36.2 V	16.8 W	174 lm/W	164 lm/W	>80
SLE 13mm 3000lm 830 R ADV8	28004563	830/359	3,039 lm	2,820 lm	500 mA	30.4 V	36.2 V	16.8 W	181 lm/W	171 lm/W	>80
SLE 13mm 3000lm 835 R ADV8	28004564	835/359	3,057 lm	2,852 lm	500 mA	30.4 V	36.2 V	16.8 W	183 lm/W	173 lm/W	>80
SLE 13mm 3000lm 840 R ADV8	28004565	840/359	3,102 lm	2,915 lm	500 mA	30.4 V	36.2 V	16.8 W	187 lm/W	176 lm/W	>80
SLE 13mm 3000lm 830 H ADV8	28004570	830/359	2,531 lm	2,820 lm	500 mA	30.4 V	36.2 V	16.8 W	181 lm/W	171 lm/W	>80
SLE 13mm 3000lm 840 H ADV8	28004571	840/359	2,584 lm	2,915 lm	500 mA	30.4 V	36.2 V	16.8 W	187 lm/W	176 lm/W	>80
SLE 13mm 3000lm – Operating mode HO at 900 mA											
SLE 13mm 3000lm 827 R ADV8	28004562	827/359	-	4,477 lm	900 mA	32.2 V	38.3 V	-	-	142 lm/W	>80
SLE 13mm 3000lm 830 R ADV8	28004563	830/359	-	4,685 lm	900 mA	32.2 V	38.3 V	-	-	149 lm/W	>80
SLE 13mm 3000lm 835 R ADV8	28004564	835/359	-	4,859 lm	900 mA	32.2 V	38.3 V	-	-	154 lm/W	>80
SLE 13mm 3000lm 840 R ADV8	28004565	840/359	-	4,925 lm	900 mA	32.2 V	38.3 V	-	-	156 lm/W	>80
SLE 13mm 3000lm 830 H ADV8	28004570	830/359	-	4,685 lm	900 mA	32.2 V	38.3 V	-	-	149 lm/W	>80
SLE 13mm 3000lm 840 H ADV8	28004571	840/359	-	4,925 lm	900 mA	32.2 V	38.3 V	-	-	156 lm/W	>80
SLE 15mm 4000lm – Operating mode HE at 400 mA											
SLE 15mm 4000lm 827 R ADV8	28004527	827/359	-	2,178 lm	400 mA	29.6 V	35.2 V	-	-	169 lm/W	>80
SLE 15mm 4000lm 830 R ADV8	28004528	830/359	-	2,258 lm	400 mA	29.6 V	35.2 V	-	-	176 lm/W	>80
SLE 15mm 4000lm 835 R ADV8	28004529	835/359	-	2,337 lm	400 mA	29.6 V	35.2 V	-	-	182 lm/W	>80
SLE 15mm 4000lm 840 R ADV8	28004530	840/359	-	2,377 lm	400 mA	29.6 V	35.2 V	-	-	185 lm/W	>80
SLE 15mm 4000lm 830 H ADV8	28004519	830/359	-	2,258 lm	400 mA	29.6 V	35.2 V	-	-	176 lm/W	>80
SLE 15mm 4000lm 840 H ADV8	28004520	840/359	-	2,377 lm	400 mA	29.6 V	35.2 V	-	-	185 lm/W	>80
SLE 15mm 4000lm 830 H ADV8 T	28004523	830/359	-	2,258 lm	400 mA	29.6 V	35.2 V	-	-	176 lm/W	>80
SLE 15mm 4000lm 840 H ADV8 T	28004524	840/359	-	2,377 lm	400 mA	29.6 V	35.2 V	-	-	185 lm/W	>80
SLE 15mm 4000lm – Operating mode NM at 800 mA											
SLE 15mm 4000lm 827 R ADV8	28004527	827/359	4,427 lm	4,169 lm	800 mA	30.8 V	36.6 V	27.1 W	166 lm/W	156 lm/W	>80
SLE 15mm 4000lm 830 R ADV8	28004528	830/359	4,659 lm	4,342 lm	800 mA	30.8 V	36.6 V	27.1 W	173 lm/W	162 lm/W	>80
SLE 15mm 4000lm 835 R ADV8	28004529	835/359	4,736 lm	4,383 lm	800 mA	30.8 V	36.6 V	27.1 W	175 lm/W	164 lm/W	>80
SLE 15mm 4000lm 840 R ADV8	28004530	840/359	4,829 lm	4,468 lm	800 mA	30.8 V	36.6 V	27.1 W	178 lm/W	167 lm/W	>80
SLE 15mm 4000lm 830 H ADV8	28004519	830/359	3,881 lm	4,342 lm	800 mA	30.8 V	36.6 V	27.1 W	173 lm/W	162 lm/W	>80
SLE 15mm 4000lm 840 H ADV8	28004520	840/359	4,023 lm	4,468 lm	800 mA	30.8 V	36.6 V	27.1 W	178 lm/W	167 lm/W	>80
SLE 15mm 4000lm 830 H ADV8 T	28004523	830/359	3,881 lm	4,342 lm	800 mA	30.8 V	36.6 V	27.1 W	173 lm/W	162 lm/W	>80
SLE 15mm 4000lm 840 H ADV8 T	28004524	840/359	4,023 lm	4,468 lm	800 mA	30.8 V	36.6 V	27.1 W	178 lm/W	167 lm/W	>80
SLE 15mm 4000lm – Operating mode HO at 1,050 mA											
SLE 15mm 4000lm 827 R ADV8	28004527	827/359	-	5,331 lm	1,050 mA	31.3 V	37.3 V	-	-	149 lm/W	>80
SLE 15mm 4000lm 830 R ADV8	28004528	830/359	-	5,570 lm	1,050 mA	31.3 V	37.3 V	-	-	156 lm/W	>80
SLE 15mm 4000lm 835 R ADV8	28004529	835/359	-	5,773 lm	1,050 mA	31.3 V	37.3 V	-	-	161 lm/W	>80
SLE 15mm 4000lm 840 R ADV8	28004530	840/359	-	5,841 lm	1,050 mA	31.3 V	37.3 V	-	-	163 lm/W	>80
SLE 15mm 4000lm 830 H ADV8	28004519	830/359	-	5,570 lm	1,050 mA	31.3 V	37.3 V	-	-	156 lm/W	>80
SLE 15mm 4000lm 840 H ADV8	28004520	840/359	-	5,841 lm	1,050 mA	31.3 V	37.3 V	-	-	163 lm/W	>80
SLE 15mm 4000lm 830 H ADV8 T	28004523	830/359	-	5,570 lm	1,050 mA	31.3 V	37.3 V	-	-	156 lm/W	>80
SLE 15mm 4000lm 840 H ADV8 T	28004524	840/359	-	5,841 lm	1,050 mA	31.3 V	37.3 V	-	-	163 lm/W	>80
SLE 17mm 5000lm – Operating mode HE at 450 mA											
SLE 17mm 5000lm 827 R ADV8	28004587	827/359	-	2,458 lm	450 mA	29.2 V	35.0 V	-	-	172 lm/W	>80

Type [®]	Article number	Photometric code [®]	Useful luminous flux at tp = 25 °C [®]	Expected luminous flux at tp rated [®]	Typ. forward current	Min. forward voltage at tp rated	Max. forward voltage at tp = 25 °C	Power consumption Pon at tp = 25 °C	Efficacy of the module at tp = 25 °C	Expected efficacy of the module at tp rated	Colour rendering index CRI
SLE 17mm 5000lm 830 R ADV8	28004588	830/359	-	2,556 lm	450 mA	29.2 V	35.0 V	-	-	179 lm/W	>80
SLE 17mm 5000lm 835 R ADV8	28004589	835/359	-	2,654 lm	450 mA	29.2 V	35.0 V	-	-	188 lm/W	>80
SLE 17mm 5000lm 840 R ADV8	28004590	840/359	-	2,700 lm	450 mA	29.2 V	35.0 V	-	-	189 lm/W	>80
SLE 17mm 5000lm 827 H ADV8	28004574	827/359	-	2,458 lm	450 mA	29.2 V	35.0 V	-	-	172 lm/W	>80
SLE 17mm 5000lm 830 H ADV8	28004575	830/359	-	2,556 lm	450 mA	29.2 V	35.0 V	-	-	179 lm/W	>80
SLE 17mm 5000lm 835 H ADV8	28004576	835/359	-	2,654 lm	450 mA	29.2 V	35.0 V	-	-	188 lm/W	>80
SLE 17mm 5000lm 840 H ADV8	28004577	840/359	-	2,700 lm	450 mA	29.2 V	35.0 V	-	-	189 lm/W	>80
SLE 17mm 5000lm 830 H ADV8 T	28004582	830/359	-	2,556 lm	450 mA	29.2 V	35.0 V	-	-	179 lm/W	>80
SLE 17mm 5000lm 840 H ADV8 T	28004583	840/359	-	2,700 lm	450 mA	29.2 V	35.0 V	-	-	189 lm/W	>80
SLE 17mm 5000lm – Operating mode NM at 900 mA											
SLE 17mm 5000lm 827 R ADV8	28004587	827/359	5,245 lm	4,878 lm	900 mA	30.4 V	36.4 V	30.3 W	173 lm/W	164 lm/W	>80
SLE 17mm 5000lm 830 R ADV8	28004588	830/359	5,463 lm	5,081 lm	900 mA	30.4 V	36.4 V	30.3 W	180 lm/W	171 lm/W	>80
SLE 17mm 5000lm 835 R ADV8	28004589	835/359	5,471 lm	5,189 lm	900 mA	30.4 V	36.4 V	30.3 W	188 lm/W	178 lm/W	>80
SLE 17mm 5000lm 840 R ADV8	28004590	840/359	5,697 lm	5,298 lm	900 mA	30.4 V	36.4 V	30.3 W	192 lm/W	182 lm/W	>80
SLE 17mm 5000lm 827 H ADV8	28004574	827/359	4,369 lm	4,878 lm	900 mA	30.4 V	36.4 V	30.3 W	173 lm/W	164 lm/W	>80
SLE 17mm 5000lm 830 H ADV8	28004575	830/359	4,551 lm	5,081 lm	900 mA	30.4 V	36.4 V	30.3 W	180 lm/W	171 lm/W	>80
SLE 17mm 5000lm 835 H ADV8	28004576	835/359	4,557 lm	5,189 lm	900 mA	30.4 V	36.4 V	30.3 W	188 lm/W	178 lm/W	>80
SLE 17mm 5000lm 840 H ADV8	28004577	840/359	4,746 lm	5,298 lm	900 mA	30.4 V	36.4 V	30.3 W	192 lm/W	182 lm/W	>80
SLE 17mm 5000lm 830 H ADV8 T	28004582	830/359	4,551 lm	5,081 lm	900 mA	30.4 V	36.4 V	30.3 W	180 lm/W	171 lm/W	>80
SLE 17mm 5000lm 840 H ADV8 T	28004583	840/359	4,746 lm	5,298 lm	900 mA	30.4 V	36.4 V	30.3 W	192 lm/W	182 lm/W	>80
SLE 17mm 5000lm – Operating mode HO at 1,200 mA											
SLE 17mm 5000lm 827 R ADV8	28004587	827/359	-	6,070 lm	1,200 mA	30.9 V	37.0 V	-	-	151 lm/W	>80
SLE 17mm 5000lm 830 R ADV8	28004588	830/359	-	6,318 lm	1,200 mA	30.9 V	37.0 V	-	-	157 lm/W	>80
SLE 17mm 5000lm 835 R ADV8	28004589	835/359	-	6,586 lm	1,200 mA	30.9 V	37.0 V	-	-	165 lm/W	>80
SLE 17mm 5000lm 840 R ADV8	28004590	840/359	-	6,672 lm	1,200 mA	30.9 V	37.0 V	-	-	167 lm/W	>80
SLE 17mm 5000lm 827 H ADV8	28004574	827/359	-	6,070 lm	1,200 mA	30.9 V	37.0 V	-	-	151 lm/W	>80
SLE 17mm 5000lm 830 H ADV8	28004575	830/359	-	6,318 lm	1,200 mA	30.9 V	37.0 V	-	-	157 lm/W	>80
SLE 17mm 5000lm 835 H ADV8	28004576	835/359	-	6,586 lm	1,200 mA	30.9 V	37.0 V	-	-	165 lm/W	>80
SLE 17mm 5000lm 840 H ADV8	28004577	840/359	-	6,672 lm	1,200 mA	30.9 V	37.0 V	-	-	167 lm/W	>80
SLE 17mm 5000lm 830 H ADV8 T	28004582	830/359	-	6,318 lm	1,200 mA	30.9 V	37.0 V	-	-	157 lm/W	>80
SLE 17mm 5000lm 840 H ADV8 T	28004583	840/359	-	6,672 lm	1,200 mA	30.9 V	37.0 V	-	-	167 lm/W	>80
SLE 21mm 6000lm – Operating mode HE at 700 mA											
SLE 21mm 6000lm 827 R ADV8	28004606	827/359	-	3,932 lm	700 mA	29.4 V	35.3 V	-	-	176 lm/W	>80
SLE 21mm 6000lm 830 R ADV8	28004607	830/359	-	4,032 lm	700 mA	29.4 V	35.3 V	-	-	180 lm/W	>80
SLE 21mm 6000lm 835 R ADV8	28004608	835/359	-	4,207 lm	700 mA	29.4 V	35.3 V	-	-	188 lm/W	>80
SLE 21mm 6000lm 840 R ADV8	28004611	840/359	-	4,224 lm	700 mA	29.4 V	35.3 V	-	-	189 lm/W	>80
SLE 21mm 6000lm 827 H ADV8	28004595	827/359	-	3,932 lm	700 mA	29.4 V	35.3 V	-	-	176 lm/W	>80
SLE 21mm 6000lm 830 H ADV8	28004596	830/359	-	4,032 lm	700 mA	29.4 V	35.3 V	-	-	180 lm/W	>80
SLE 21mm 6000lm 840 H ADV8	28004597	840/359	-	4,224 lm	700 mA	29.4 V	35.3 V	-	-	189 lm/W	>80
SLE 21mm 6000lm 830 H ADV8 T	28004602	830/359	-	4,032 lm	700 mA	29.4 V	35.3 V	-	-	180 lm/W	>80
SLE 21mm 6000lm 840 H ADV8 T	28004603	840/359	-	4,224 lm	700 mA	29.4 V	35.3 V	-	-	189 lm/W	>80
SLE 21mm 6000lm – Operating mode NM at 1,200 mA											
SLE 21mm 6000lm 827 R ADV8	28004606	827/359	7,112 lm	6,614 lm	1,200 mA	30.3 V	36.2 V	40.3 W	177 lm/W	168 lm/W	>80
SLE 21mm 6000lm 830 R ADV8	28004607	830/359	7,392 lm	6,890 lm	1,200 mA	30.3 V	36.2 V	40.3 W	184 lm/W	175 lm/W	>80
SLE 21mm 6000lm 835 R ADV8	28004608	835/359	7,566 lm	7,036 lm	1,200 mA	30.3 V	36.2 V	40.3 W	188 lm/W	178 lm/W	>80
SLE 21mm 6000lm 840 R ADV8	28004611	840/359	7,725 lm	7,184 lm	1,200 mA	30.3 V	36.2 V	40.3 W	192 lm/W	182 lm/W	>80
SLE 21mm 6000lm 827 H ADV8	28004595	827/359	5,924 lm	6,614 lm	1,200 mA	30.3 V	36.2 V	40.3 W	177 lm/W	168 lm/W	>80
SLE 21mm 6000lm 830 H ADV8	28004596	830/359	6,158 lm	6,890 lm	1,200 mA	30.3 V	36.2 V	40.3 W	184 lm/W	175 lm/W	>80
SLE 21mm 6000lm 840 H ADV8	28004597	840/359	6,435 lm	7,184 lm	1,200 mA	30.3 V	36.2 V	40.3 W	192 lm/W	182 lm/W	>80
SLE 21mm 6000lm 830 H ADV8 T	28004602	830/359	6,158 lm	6,890 lm	1,200 mA	30.3 V	36.2 V	40.3 W	184 lm/W	175 lm/W	>80
SLE 21mm 6000lm 840 H ADV8 T	28004603	840/359	6,435 lm	7,184 lm	1,200 mA	30.3 V	36.2 V	40.3 W	192 lm/W	182 lm/W	>80
SLE 21mm 6000lm – Operating mode HO at 1,800 mA											
SLE 21mm 6000lm 827 R ADV8	28004606	827/359	-	9,348 lm	1,800 mA	31.1 V	37.3 V	-	-	153 lm/W	>80
SLE 21mm 6000lm 830 R ADV8	28004607	830/359	-	9,665 lm	1,800 mA	31.1 V	37.3 V	-	-	159 lm/W	>80
SLE 21mm 6000lm 835 R ADV8	28004608	835/359	-	10,064 lm	1,800 mA	31.1 V	37.3 V	-	-	165 lm/W	>80
SLE 21mm 6000lm 840 R ADV8	28004611	840/359	-	10,159 lm	1,800 mA	31.1 V	37.3 V	-	-	167 lm/W	>80
SLE 21mm 6000lm 827 H ADV8	28004595	827/359	-	9,348 lm	1,800 mA	31.1 V	37.3 V	-	-	153 lm/W	>80
SLE 21mm 6000lm 830 H ADV8	28004596	830/359	-	9,665 lm	1,800 mA	31.1 V	37.3 V	-	-	159 lm/W	>80
SLE 21mm 6000lm 840 H ADV8	28004597	840/359	-	10,159 lm	1,800 mA	31.1 V	37.3 V	-	-	167 lm/W	>80
SLE 21mm 6000lm 830 H ADV8 T	28004602	830/359	-	9,665 lm	1,800 mA	31.1 V	37.3 V	-	-	159 lm/W	>80
SLE 21mm 6000lm 840 H ADV8 T	28004603	840/359	-	10,159 lm	1,800 mA	31.1 V	37.3 V	-	-	167 lm/W	>80

② If mounted with M4 screws with 7 mm head diameter.

③ HE ... High Efficiency, NM ... Nominal Mode, HO ... High Output.

④ The detailed explanation, see data sheet section 1.1.

⑤ Tolerance of useful light flux - 0 % / + 15 %. Measurement uncertainty ± 10 %.

⑥ Measurement uncertainty ± 10 %. Based on calculation.

⑦ Tolerance of power consumption Pon ± 10 %. Measurement uncertainty ± 5 %.

Housing for SLE

Accessory

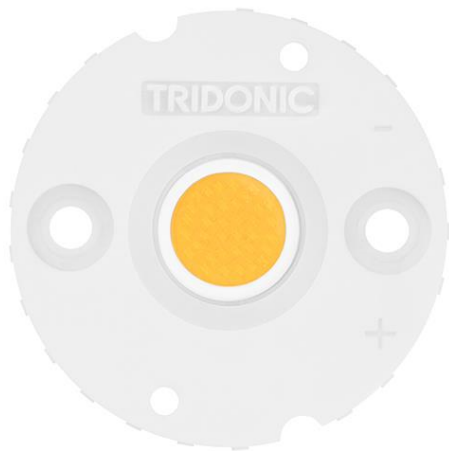

Product description

- _ Housing for SLE
- _ Diameter: 35 mm
- _ Material: Lexan Resin 943
- _ M3 screws with flat head, max. head diameter of 6 mm and max. torque for fixing is 0.5 Nm

Website

<http://www.tridonic.com/28003024>



LES09

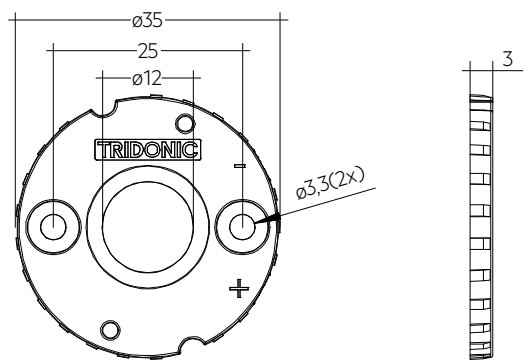

SLE G7 HOUSING LES09

Ordering data

Type	Article number	Packaging, bag	Weight per pc.
SLE G7 HOUSING LES 09	28003024	500 pc(s).	0.002 kg
SLE G7 HOUSING LES 13/15	28003026	500 pc(s).	0.002 kg

1. Standards

EN 62031
 EN 62471
 IEC 62717
 IEC 61000-4-2
 UL 8750 (for CLASS2 circuits and dry locations)

1.1 Glow wire test for housing variants

according to IEC 60695-2-11 with increased temperature of 850 °C passed.

1.2 Photometric code

Key for photometric code, e. g. 830 / 359

1 st digit	2 nd + 3 rd digit	4 th digit	5 th digit	6 th digit	
Code CRI	Colour temperature in Kelvin x 100	MacAdam initial	MacAdam after 25% of the lifetime (max.6000h)	Luminous flux after 25% of the lifetime (max.6000h)	
				Code	Luminous flux
7 70 – 79				7	≥ 70 %
8 80 – 89				8	≥ 80 %
9 ≥90			9	≥ 90 %	

1.3 Risk group

Type	Risk group (IEC 62471)
LES09 800lm 3000K	RG1
LES09 800lm 4000K (at I _{max})	RG2 (Eth _r = 1,808 lx, RG1 at d ≥ 730 mm)
LES09 800lm 4000K (at I ≤ 350 mA)	RG2 (Eth _r = 1,808 lx, RG1 at d ≥ 620 mm)
LES09 1200lm 3000K	RG1
LES09 1200lm 4000K (at I _{max})	RG2 (Eth _r = 1,808 lx, RG1 at d ≥ 770 mm)
LES09 1200lm 4000K (at I ≤ 350 mA)	RG2 (Eth _r = 1,808 lx, RG1 at d ≥ 620 mm)
LES13	RG1
LES15	RG1
LES17	RG1
LES21	RG1

1.4 Energy classification

Type	Colour temperature	Forward current	Energy classification	Energy consumption
SLE 09mm – Without housing				
SLE 09mm 800lm 830 R ADV8	3,000 K	350 mA	D	13 kWh / 1,000 h
SLE 09mm 800lm 840 R ADV8	4,000 K	350 mA	C	13 kWh / 1,000 h
SLE 09mm 1200lm 830 R ADV8	3,000 K	350 mA	D	12 kWh / 1,000 h
SLE 09mm 1200lm 840 R ADV8	4,000 K	350 mA	C	12 kWh / 1,000 h
SLE 13mm – Without housing				
SLE 13mm 3000lm 827 R ADV8	2,700 K	500 mA	D	17 kWh / 1,000 h
SLE 13mm 3000lm 830 R ADV8	3,000 K	500 mA	C	17 kWh / 1,000 h
SLE 13mm 3000lm 835 R ADV8	3,500 K	500 mA	C	17 kWh / 1,000 h
SLE 13mm 3000lm 840 R ADV8	4,000 K	500 mA	C	17 kWh / 1,000 h

Type	Colour temperature	Forward current	Energy classification	Energy consumption
SLE 15mm – Without housing				
SLE 15mm 4000lm 827 R ADV8	2,700 K	800 mA	D	27 kWh / 1,000 h
SLE 15mm 4000lm 830 R ADV8	3,000 K	800 mA	D	27 kWh / 1,000 h
SLE 15mm 4000lm 835 R ADV8	3,500 K	800 mA	C	28 kWh / 1,000 h
SLE 15mm 4000lm 840 R ADV8	4,000 K	800 mA	C	28 kWh / 1,000 h
SLE 17mm – Without housing				
SLE 17mm 5000lm 827 R ADV8	2,700 K	900 mA	C	31 kWh / 1,000 h
SLE 17mm 5000lm 830 R ADV8	3,000 K	900 mA	C	31 kWh / 1,000 h
SLE 17mm 5000lm 835 R ADV8	3,500 K	900 mA	C	31 kWh / 1,000 h
SLE 17mm 5000lm 840 R ADV8	4,000 K	900 mA	C	31 kWh / 1,000 h
SLE 21mm – Without housing				
SLE 21mm 6000lm 827 R ADV8	2,700 K	1,200 mA	C	41 kWh / 1,000 h
SLE 21mm 6000lm 830 R ADV8	3,000 K	1,200 mA	C	41 kWh / 1,000 h
SLE 21mm 6000lm 835 R ADV8	3,500 K	1,200 mA	C	41 kWh / 1,000 h
SLE 21mm 6000lm 840 R ADV8	4,000 K	1,200 mA	C	41 kWh / 1,000 h
SLE 13mm – With housing				
SLE 13mm 3000lm 830 H ADV8	3,000 K	500 mA	C	17 kWh / 1,000 h
SLE 13mm 3000lm 840 H ADV8	4,000 K	500 mA	C	17 kWh / 1,000 h
SLE 15mm – With housing				
SLE 15mm 4000lm 830 H ADV8	3,000 K	800 mA	D	27 kWh / 1,000 h
SLE 15mm 4000lm 840 H ADV8	4,000 K	800 mA	C	28 kWh / 1,000 h
SLE 15mm 4000lm 830 H ADV8 T	3,000 K	800 mA	D	27 kWh / 1,000 h
SLE 15mm 4000lm 840 H ADV8 T	4,000 K	800 mA	C	28 kWh / 1,000 h
SLE 17mm – With housing				
SLE 17mm 5000lm 827 H ADV8	2,700 K	900 mA	D	31 kWh / 1,000 h
SLE 17mm 5000lm 830 H ADV8	3,000 K	900 mA	C	31 kWh / 1,000 h
SLE 17mm 5000lm 835 H ADV8	3,500 K	900 mA	C	31 kWh / 1,000 h
SLE 17mm 5000lm 840 H ADV8	4,000 K	900 mA	C	31 kWh / 1,000 h
SLE 17mm 5000lm 830 H ADV8 T	3,000 K	900 mA	C	31 kWh / 1,000 h
SLE 17mm 5000lm 840 H ADV8 T	4,000 K	900 mA	C	31 kWh / 1,000 h
SLE 21mm – With housing				
SLE 21mm 6000lm 827 H ADV8	2,700 K	1,200 mA	C	41 kWh / 1,000 h
SLE 21mm 6000lm 830 H ADV8	3,000 K	1,200 mA	C	41 kWh / 1,000 h
SLE 21mm 6000lm 840 H ADV8	4,000 K	1,200 mA	C	41 kWh / 1,000 h
SLE 21mm 6000lm 830 H ADV8 T	3,000 K	1,200 mA	C	41 kWh / 1,000 h
SLE 21mm 6000lm 840 H ADV8 T	4,000 K	1,200 mA	C	41 kWh / 1,000 h

2. Thermal details

2.1 tp point, ambient temperature and lifetime

The temperature at tp reference point is crucial for the light output and lifetime of a LED product.

For SLE a tp temperature of 65 °C has to be complied in order to achieve an optimum between heat sink requirements, light output and lifetime.

Compliance with the maximum permissible reference temperature at the tp point must be checked under operating conditions in a thermally stable state. The maximum value must be determined under worst-case conditions for the relevant application.

The tc and tp temperature of LED modules from Tridonic are measured at the same reference point.

To check the tc / tp temperature, the temperature sensor has to be mounted on the PCB at the marked position as stated in the drawing.

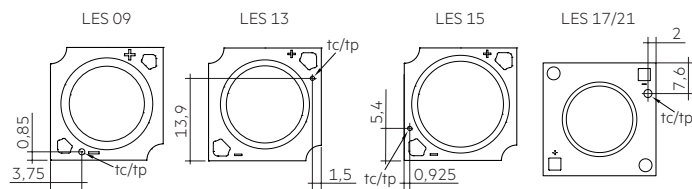

2.2 Storage and humidity

storage temperature	-30... +80 °C
---------------------	---------------

Operation only in non condensing environment.

Humidity during processing of the module should be between 0 to 85 %.

2.3 Thermal design and heat sink

The rated life of LED products depends to a large extent on the temperature. If the permissible temperature limits are exceeded, the life of the SLE will be greatly reduced or the SLE may be destroyed.

2.4 Heat sink values

SLE 09mm 800lm xxx ADV8

ta	tp	Operating current	R _{th, hs-a}
25 °C	65 °C	250 mA	4.8 K/W
35 °C	65 °C	250 mA	3.6 K/W
45 °C	65 °C	250 mA	2.4 K/W
25 °C	65 °C	350 mA	3.1 K/W
35 °C	65 °C	350 mA	2.3 K/W
45 °C	65 °C	350 mA	1.5 K/W
25 °C	65 °C	450 mA	2.3 K/W
35 °C	65 °C	450 mA	1.7 K/W
45 °C	65 °C	450 mA	1.1 K/W

SLE 09mm 1200lm xxx ADV8

ta	tp	Operating current	R _{th, hs-a}
25 °C	65 °C	250 mA	4.6 K/W
35 °C	65 °C	250 mA	3.4 K/W
45 °C	65 °C	250 mA	2.2 K/W
25 °C	65 °C	350 mA	3.1 K/W
35 °C	65 °C	350 mA	2.3 K/W
45 °C	65 °C	350 mA	1.5 K/W
25 °C	65 °C	500 mA	2.1 K/W
35 °C	65 °C	500 mA	1.6 K/W
45 °C	65 °C	500 mA	1.0 K/W

SLE 13mm 3000lm xxx ADV8

ta	tp	Operating current	R _{th, hs-a}
25 °C	65 °C	350 mA	3.4 K/W
35 °C	65 °C	350 mA	2.6 K/W
45 °C	65 °C	350 mA	1.7 K/W
25 °C	65 °C	500 mA	2.3 K/W
35 °C	65 °C	500 mA	1.7 K/W
45 °C	65 °C	500 mA	1.2 K/W
25 °C	65 °C	900 mA	1.2 K/W
35 °C	65 °C	900 mA	0.9 K/W
45 °C	65 °C	900 mA	0.6 K/W

SLE 15mm 4000lm xxx ADV8

ta	tp	Operating current	R _{th, hs-a}
25 °C	65 °C	400 mA	2.4 K/W
35 °C	65 °C	400 mA	1.8 K/W
45 °C	65 °C	400 mA	1.2 K/W
25 °C	65 °C	800 mA	1.3 K/W
35 °C	65 °C	800 mA	1.0 K/W
45 °C	65 °C	800 mA	0.6 K/W
25 °C	65 °C	1,050 mA	0.9 K/W
35 °C	65 °C	1,050 mA	0.7 K/W
45 °C	65 °C	1,050 mA	0.5 K/W

SLE 17mm 5000lm xxx ADV8

ta	tp	Operating current	R _{th, hs-a}
25 °C	65 °C	450 mA	2.3 K/W
35 °C	65 °C	450 mA	1.7 K/W
45 °C	65 °C	450 mA	1.1 K/W
25 °C	65 °C	900 mA	1.0 K/W
35 °C	65 °C	900 mA	0.7 K/W
45 °C	65 °C	900 mA	0.4 K/W
25 °C	65 °C	1,200 mA	0.7 K/W
35 °C	65 °C	1,200 mA	0.5 K/W
45 °C	65 °C	1,200 mA	0.3 K/W

SLE 21mm 6000lm xxx ADV8

ta	tp	Operating current	R _{th, hs-a}
25 °C	65 °C	700 mA	1.6 K/W
35 °C	65 °C	700 mA	1.2 K/W
45 °C	65 °C	700 mA	0.8 K/W
25 °C	65 °C	1,200 mA	0.7 K/W
35 °C	65 °C	1,200 mA	0.5 K/W
45 °C	65 °C	1,200 mA	0.3 K/W
25 °C	65 °C	1,800 mA	0.5 K/W
35 °C	65 °C	1,800 mA	0.3 K/W
45 °C	65 °C	1,800 mA	0.2 K/W

Notes

The actual cooling can differ because of the material, the structural shape, outside influences and the installation situation. A thermal connection between SLE and heat sink with heat-conducting paste or heat conducting adhesive film is absolutely necessary.

Additionally the SLE has to be fixed on the heat sink with M3 screws to optimise the thermal connection.

Use of thermal interface material with thermal conductivity of $\lambda > 1 \text{ W/mK}$ and layer thickness of interface material with max. 50 μm or a similar interface material where the quotient of layer thickness and thermal conductivity $b < 50 \mu\text{mmK/W}$.

The SLE H ADV8 T modules will be delivered with thermal interface foil of type GRAFTECH HT-1205A.

The bottom side of the thermal pad is glued to the module, the upper side is not adhesive. This makes it easier to position the module when it is connected to the heat sink.



The thermal pad is an integral part of the LED module and must not be confused with a protective foil. The thermal pad must not be pulled off!

For further information about the thermal interface foil please refer to the data sheet of the product GRAFTECH HT-1205A.

3. Installation / wiring

3.1 Electrical supply/choice of LED driver

SLE from Tridonic are not protected against overvoltages, overcurrents, overloads or short-circuit currents. Safe and reliable operation can only be guaranteed in conjunction with a LED driver which complies with the relevant standards. The use of LED drivers from Tridonic in combination with SLE guarantees the necessary protection for safe and reliable operation.

If a LED driver other than Tridonic is used, it must provide the following protection:

- Short-circuit protection
- Overload protection
- Overtemperature protection



SLE must be supplied by a constant current LED driver. Operation with a constant voltage LED driver will lead to an irreversible damage of the module. Wrong polarity can damage the SLE.



SLE must not be operated with nonSELV LED driver.



SLE are basic insulated up to 60 V SELV against ground and can be mounted directly on earthed metal parts of the luminaire. If the max. output voltage of the LED driver (also against earth) is above 60 V SELV, an additional insulation between LED module and heat sink is required (for example by insulated thermal pads) or by a suitable luminaire construction.

At voltages > 60 V an additional protection against direct touch (test finger) to the light emitting side of the module has to be guaranteed. This is typically achieved by means of a non removable light distributor over the module.

3.2 Wiring

Wiring with housing (LES13 and LES15)

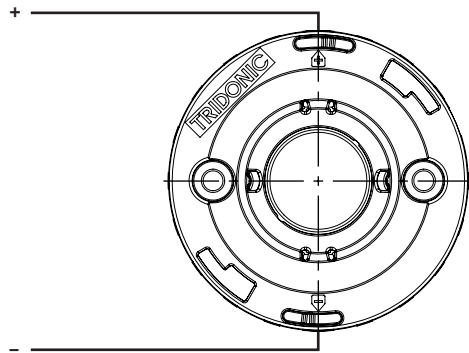

Wiring with housing (LES17 and LES21)

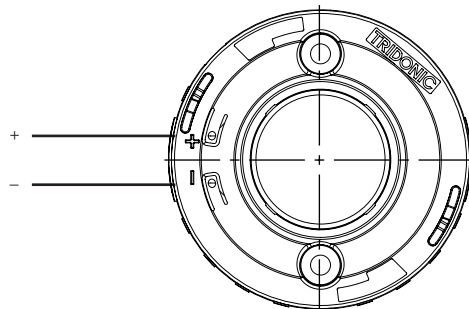

Wiring without housing

LES09 + LES13 + LES15

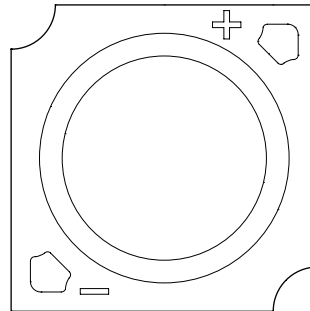

LES17 + LES21

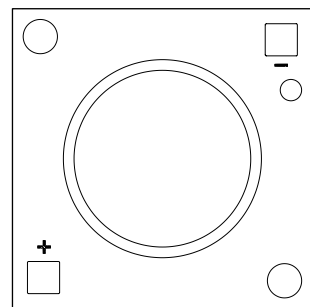

Wiring example

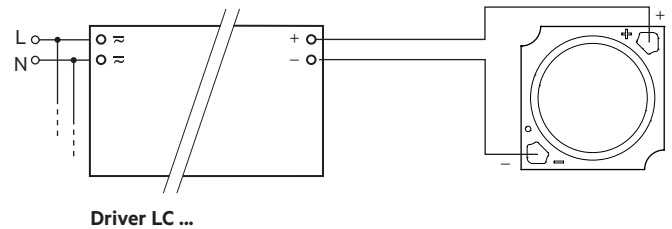

3.3 Wiring type and cross section for housing variants

For wiring use solid wire from 0.5 to 0.75 mm² or stranded wire with soldered ends of 0.5 mm².

For the push-wire connection you have to strip the insulation (6 – 7 mm).

Loosen wire through twisting and pulling.

wire preparation:

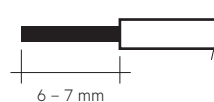

3.4 Mounting instruction



SLE from Tridonic which have to be installed on a heat sink have to be connected with heat-conducting paste or heat conducting adhesive film and fixed with M3 screws.

The fixing/cooling surface must be cleaned by removing all dirt, dust and grease before installing the LED modules.

None of the components of the SLE (substrate, LED, electronic components etc.) may be exposed to tensile or compressive stresses.



Max. torque for fixing: 0,3 Nm (LES9, LES13, LES15)
0,5 Nm (LES17, LES21)

The LED modules are mounted with 2 screws per module. In order not to damage the modules only rounded head screws and an additional plastic flat washer (notice working temperature) or rounded head screw with collar (ISO 7380-2) with head diameter $\leq 6,9$ mm must be used for LED modules without housing (for LES13, LES15).

Chemical substance may harm the LED module. Chemical reactions could lead to colour shift, reduced luminous flux or a total failure of the module caused by corrosion of electrical connections.



Materials which are used in LED applications (e.g. sealings, adhesives) must not produce dissolver gas. They must not be condensation curing based, acetate curing based or contain sulfur, chlorine or phthalate.

Avoid corrosive atmosphere during usage and storage.

3.5 EOS/ESD safety guidelines



The device / module contains components that are sensitive to electrostatic discharge and may only be installed in the factory and on site if appropriate EOS/ESD protection measures have been taken. No special measures need be taken for devices/modules with enclosed casings (contact with the pc board not possible), just normal installation practice.

For further information for EOS/ESD safety guidelines and the ESD classification please refer to the brochure entitled <http://www.tridonic.com/esd-protection>.

4. Lifetime

4.1 Lifetime, lumen maintenance and failure rate

The light output of an LED module decreases over the lifetime, this is characterized with the L value. L70 means that the LED module will give 70 % of its initial luminous flux. This value is always related to the number of operation hours and therefore defines the lifetime of an LED module.

As the L value is a statistical value and the lumen maintenance may vary over the delivered LED modules. The B value defines the amount of modules which are below the specific L value, e.g. L70B10 means 10 % of the LED modules are below 70 % of the initial luminous flux, respectively 90 % will be above 70 % of the initial value.

In addition the percentage of failed modules (fatal failure) is characterized by the C value.

The F value is the combination of the B and C value. That means for F degradation and complete failures are considered, e.g. L70F10 means 10 % of the LED modules may fail or be below 70 % of the initial luminous flux.

4.2 Lumen maintenance

Lifetime declarations are informative and represent no warranty claim. Preliminary calculated lifetime data until LM80 test reports are available

SLE 09mm 800lm ADV8

Operating current	tp temperature	L90 / F10	L90 / F50	L80 / F10	L80 / F50	L70 / F10	L70 / F50
250 mA	65 °C	57k h	>60k h	>60k h	>60k h	>60k h	>60k h
	85 °C	57k h	>60k h	>60k h	>60k h	>60k h	>60k h
	105 °C	9k h	14k h	20k h	31k h	20k h	33k h
350 mA	65 °C	>60k h	>60k h	>60k h	>60k h	>60k h	>60k h
	85 °C	36k h	>38k h	>60k h	>60k h	>60k h	>60k h
450 mA	65 °C	>60k h	>60k h	>60k h	>60k h	>60k h	>60k h
	85 °C	36k h	38k h	>60k h	>60k h	>60k h	>60k h

SLE 09mm 1200lm ADV8

Operating current	tp temperature	L90 / F10	L90 / F50	L80 / F10	L80 / F50	L70 / F10	L70 / F50
250 mA	65 °C	>60k h	>60k h	>60k h	>60k h	>60k h	>60k h
	85 °C	57k h	>60k h	>60k h	>60k h	>60k h	>60k h
	105 °C	18k h	22k h	10k h	51k h	>60k h	>60k h
350 mA	65 °C	>60k h	>60k h	>60k h	>60k h	>60k h	>60k h
	85 °C	57k h	>60k h	>60k h	>60k h	>60k h	>60k h
	105 °C	18k h	>22k h	41k h	51k h	>60k h	>60k h
500 mA	65 °C	57k h	>60k h	>60k h	>60k h	>60k h	>60k h
	85 °C	57k h	>60k h	>60k h	>60k h	>60k h	>60k h
	105 °C	9k h	14k h	20k h	31k h	33k h	50k h

SLE 13mm 3000lm ADV8

Operating current	tp temperature	L90 / F10	L90 / F50	L80 / F10	L80 / F50	L70 / F10	L70 / F50
350 mA	65 °C	>60k h	>60k h	>60k h	>60k h	>60k h	>60k h
	85 °C	57k h	>60k h	>60k h	>60k h	>60k h	>60k h
	105 °C	18k h	22k h	41k h	51k h	>60k h	>60k h
500 mA	65 °C	>60k h	>60k h	>60k h	>60k h	>60k h	>60k h
	85 °C	57k h	>60k h	>60k h	>60k h	>60k h	>60k h
	105 °C	18k h	22k h	41k h	51k h	33k h	50k h
900 mA	65 °C	>60k h	>60k h	>60k h	>60k h	>60k h	>60k h
	85 °C	36k h	38k h	>60k h	>60k h	>60k h	>60k h

SLE 15mm 4000lm ADV8

Operating current	tp temperature	L90 / F10	L90 / F50	L80 / F10	L80 / F50	L70 / F10	L70 / F50
400 mA	65 °C	>60k h	>60k h	>60k h	>60k h	>60k h	>60k h
	85 °C	57k h	>60k h	>60k h	>60k h	>60k h	>60k h
	105 °C	18k h	22k h	41k h	51k h	>60 kh	>60k h
800 mA	65 °C	>60k h	>60k h	>60k h	>60k h	>60k h	>60k h
	85 °C	57k h	>60k h	>60k h	>60k h	>60k h	>60k h
	105 °C	18k h	22k h	41k h	51k h	>60 kh	50k h
1,050 mA	65 °C	57k h	>60k h	>60k h	>60k h	>60k h	>60k h
	85 °C	57k h	>60k h	>60k h	>60k h	>60k h	>60k h
	105 °C	9k h	14k h	20k h	31k h	33k h	50k h

SLE 17mm 5000lm ADV8

Operating current	tp temperature	L90 / F10	L90 / F50	L80 / F10	L80 / F50	L70 / F10	L70 / F50
450 mA	65 °C	>60k h	>60k h	>60k h	>60k h	>60k h	>60k h
	85 °C	57k h	>60k h	>60k h	>60k h	>60k h	>60k h
	105 °C	18k h	22k h	41k h	51k h	>60k h	>60k h
900 mA	65 °C	>60k h	>60k h	>60k h	>60k h	>60k h	>60k h
	85 °C	57k h	>60k h	>60k h	>60k h	>60k h	>60k h
	105 °C	18k h	22k h	41k h	51k h	>60k h	50k h
1,200 mA	65 °C	57k h	>60k h	>60k h	>60k h	>60k h	>60k h
	85 °C	57k h	>60k h	>60k h	>60k h	>60k h	>60k h
	105 °C	9k h	14k h	20k h	31k h	33k h	50k h

SLE 21mm 6000lm ADV8

Operating current	tp temperature	L90 / F10	L90 / F50	L80 / F10	L80 / F50	L70 / F10	L70 / F50
700 mA	65 °C	>60k h	>60k h	>60k h	>60k h	>60k h	>60k h
	85 °C	57k h	>60k h	>60k h	>60k h	>60k h	>60k h
	105 °C	18k h	22k h	41k h	51k h	>60k h	>60k h
1,200 mA	65 °C	>60k h	>60k h	>60k h	>60k h	>60k h	>60k h
	85 °C	57k h	>60k h	>60k h	>60k h	>60k h	>60k h
	105 °C	18k h	22k h	41k h	51k h	>60k h	50k h
1,800 mA	65 °C	57k h	>60k h	>60k h	>60k h	>60k h	>60k h
	85 °C	57k h	>60k h	>60k h	>60k h	>60k h	>60k h
	105 °C	9k h	14k h	20k h	31k h	33k h	50k h

5. Electrical values

5.1 Declaration of electrical parameters

Irated ... Nominal operating current the module is designed for.

I_{max} ... Max. permissible continuous operating current incl. The tolerances of the LED driver.

Max. permissible LF current ripple ... Max. output current of the LED driver incl. Tolerances and LF current ripple must not exceed this value.

Max. permissible peak current ... The max. output peak current of the LED driver must not exceed this value.

5.2 Typ. forward voltage vs. forward current

SLE 09mm 800lm ADV8

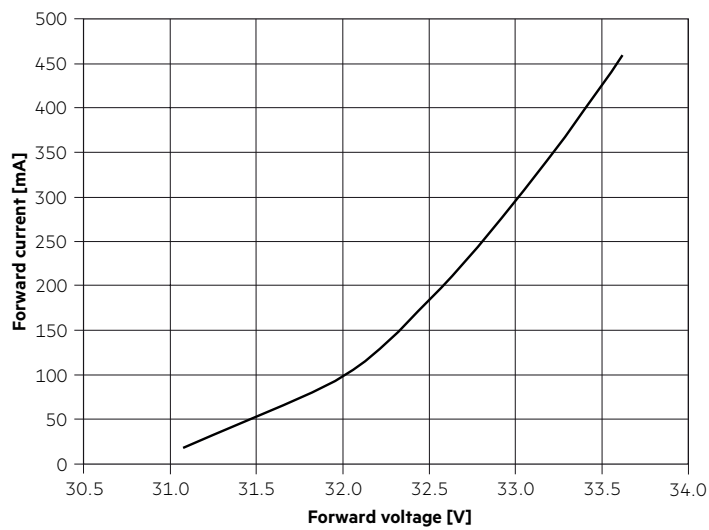

SLE 09mm 1200lm ADV8

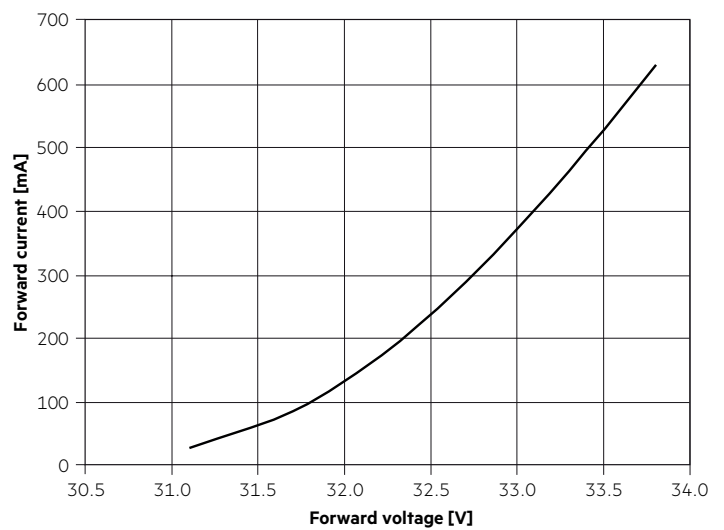

SLE 13mm 3000lm ADV8

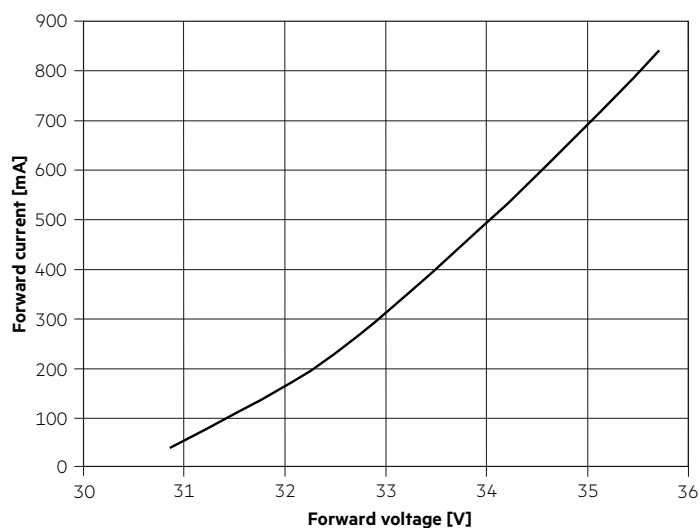

SLE 15mm 4000lm ADV8

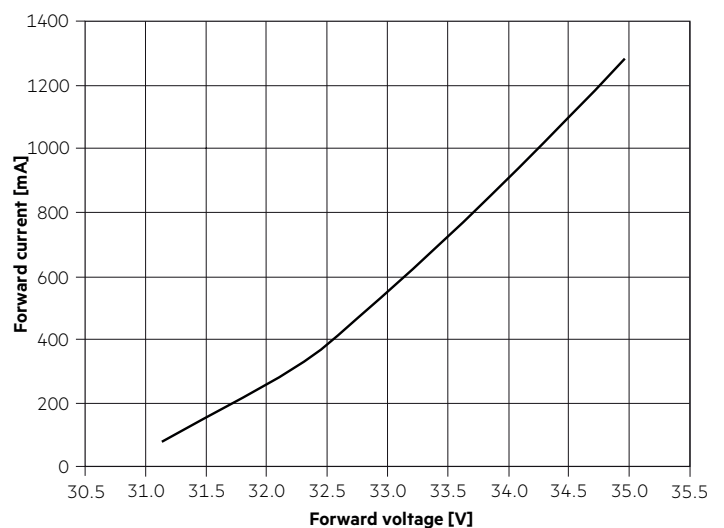

SLE 17mm 5000lm ADV8

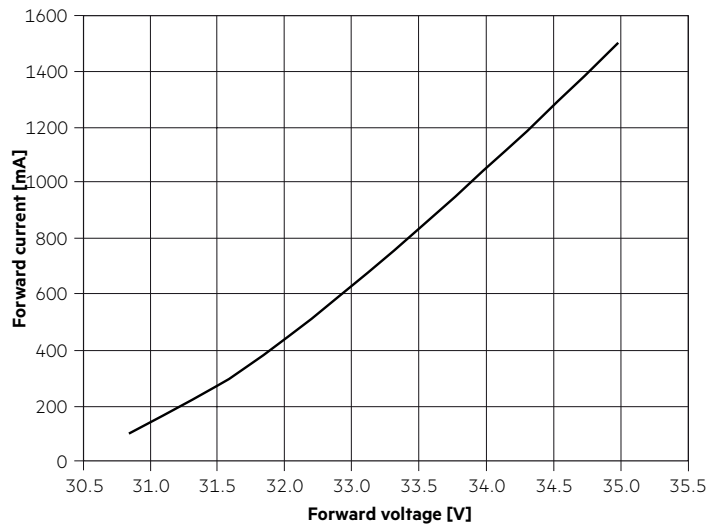

SLE 21mm 6000lm ADV8

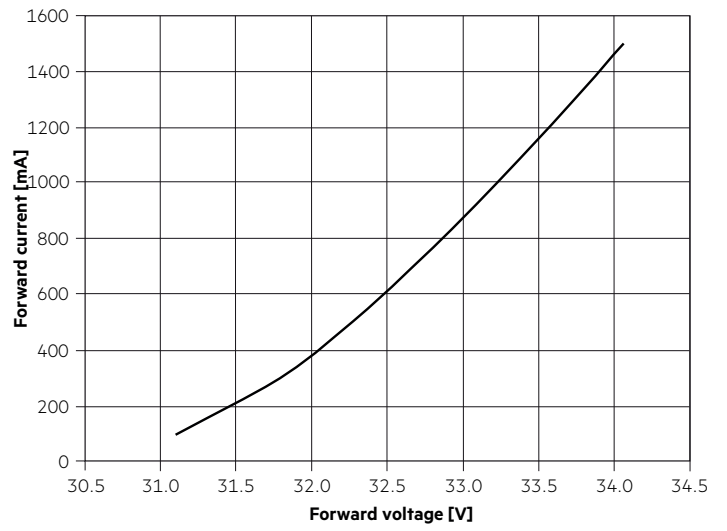

5.3 Forward voltage vs. tp temperature

SLE 09mm 800lm ADV8

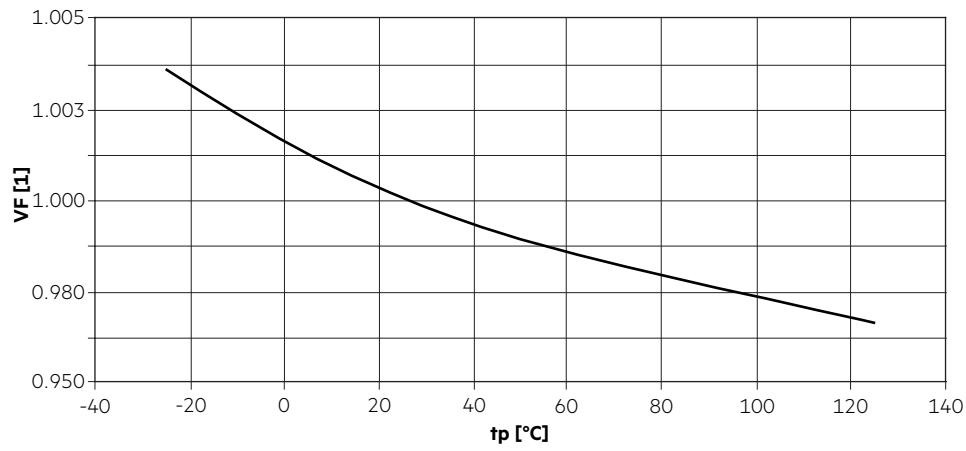

SLE 09mm 1200lm ADV8

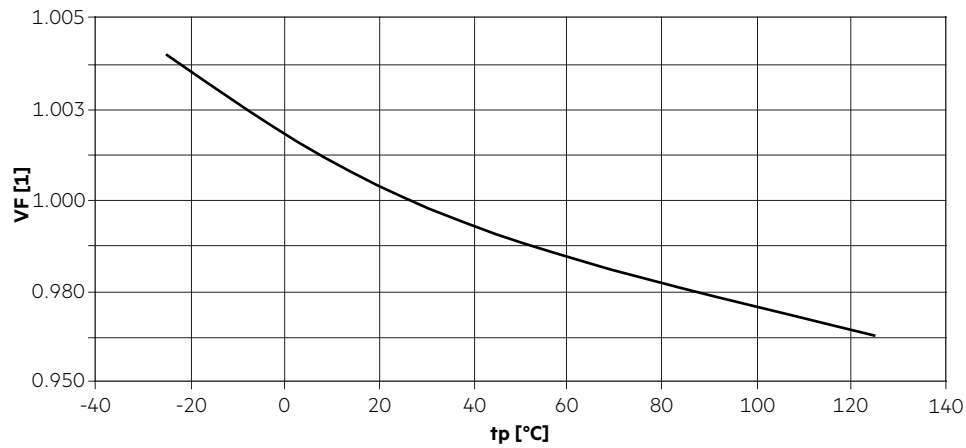

SLE 13mm 3000lm ADV8

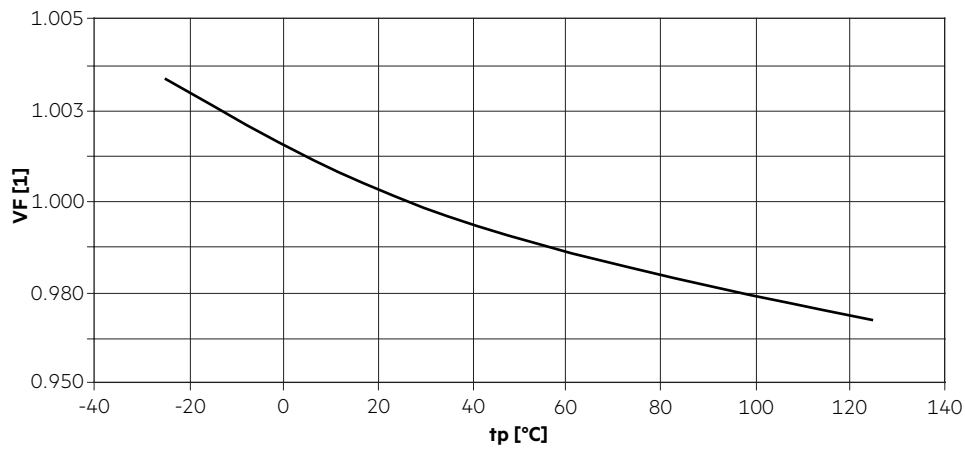

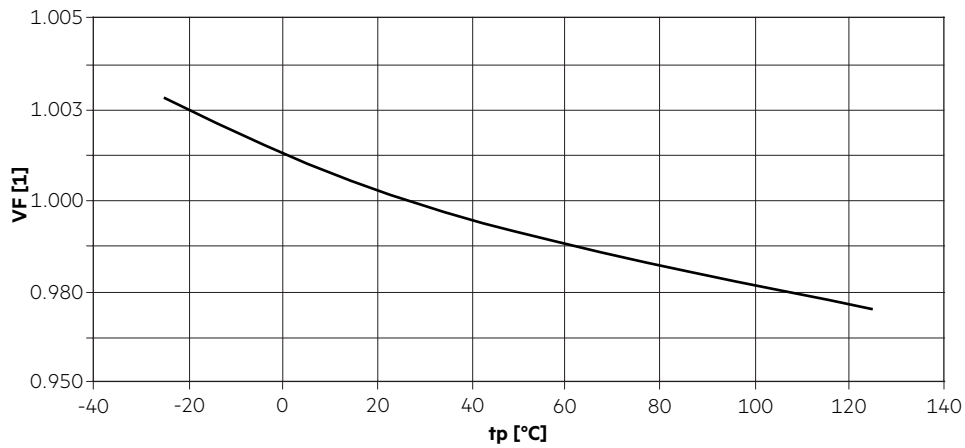
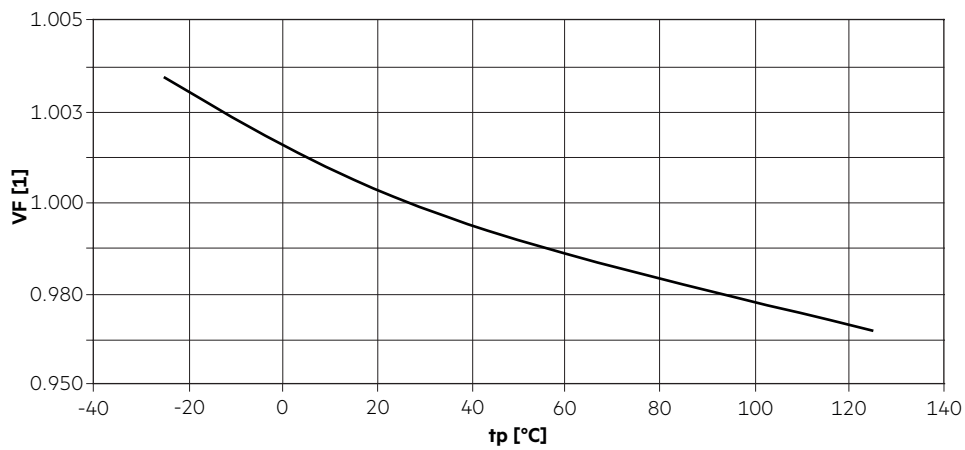
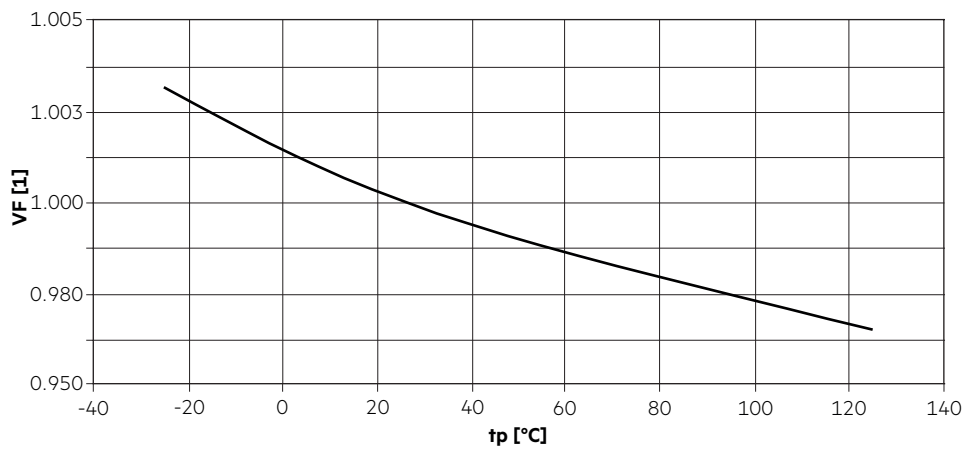
SLE 15mm 4000lm ADV8**SLE 17mm 5000lm ADV8****SLE 21mm 6000lm ADV8**

The diagrams based on statistic values.
The real values can be different.

6. Photometric characteristics

6.1 Coordinates and tolerances according to CIE 1931 and colour rendering

The specified colour coordinates are measured integral after a settling time of 100 ms. The current impuls depends on the module type. The ambient temperature of the measurement is $t_a = 25^\circ\text{C}$. The measurement tolerance of the colour coordinates are ± 0.005 .

Module type	Current impulse
SLE 09mm 800 / 1200lm xxx ADV8	350 mA
SLE 13mm 3000lm xxx ADV8	500 mA
SLE 15mm 4000lm xxx ADV8	800 mA
SLE 17mm 5000lm xxx ADV8	900 mA
SLE 21mm 6000lm xxx ADV8	1200 mA

2,700 K – CRI80

	x0	y0
Centre	0.4599	0.4106

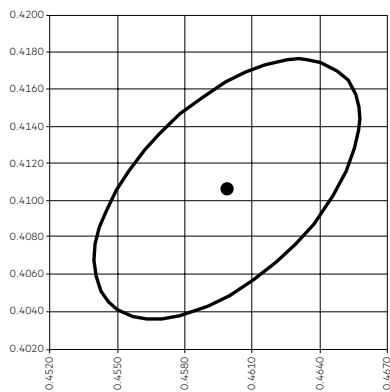

MacAdam ellipse: 3SDCM

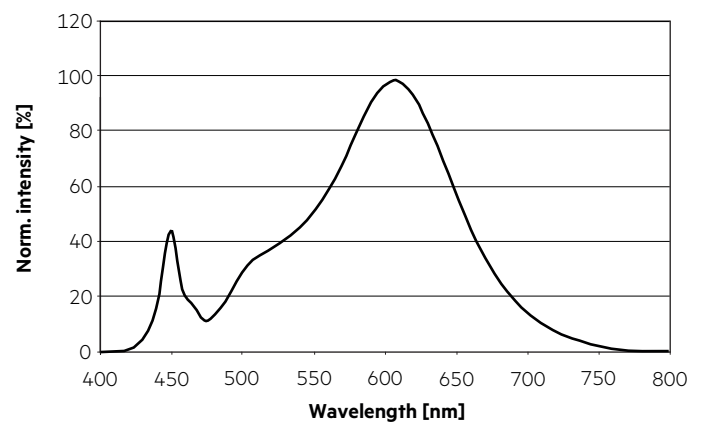

3,000 K – CRI80

	x0	y0
Centre	0.4369	0.4041

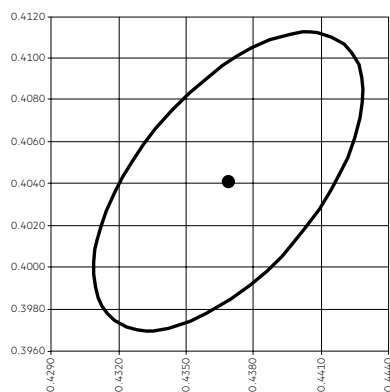

MacAdam ellipse: 3SDCM

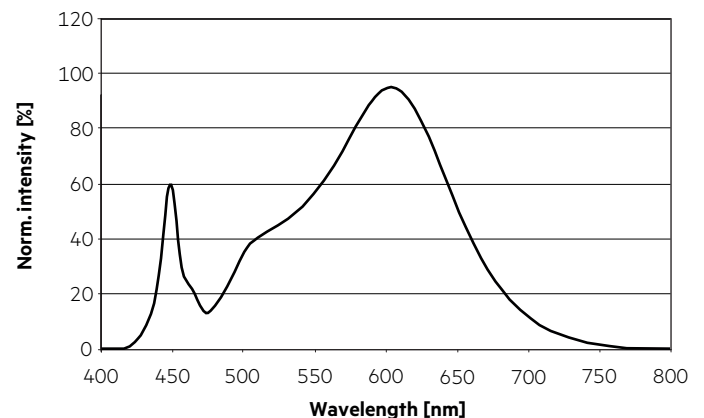

3,500 K - CRI80

	x0	y0
Centre	0.4053	0.3907

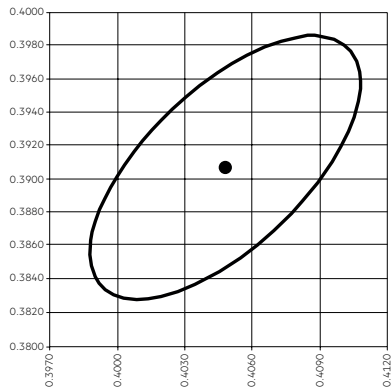

MacAdam ellipse: 3SDCM

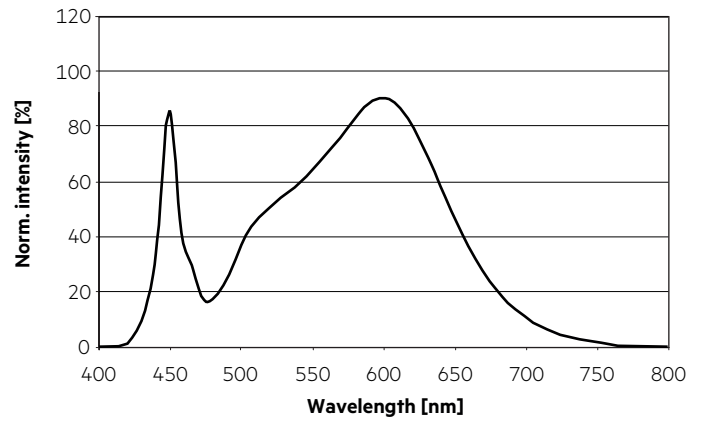

4,000 K - CRI80

	x0	y0
Centre	0.3804	0.3767

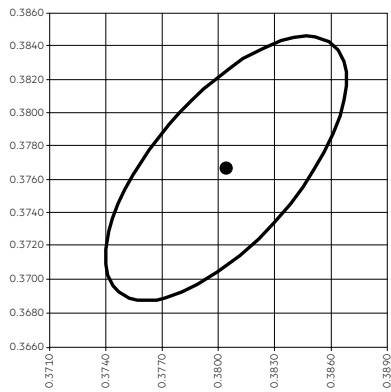

MacAdam ellipse: 3SDCM

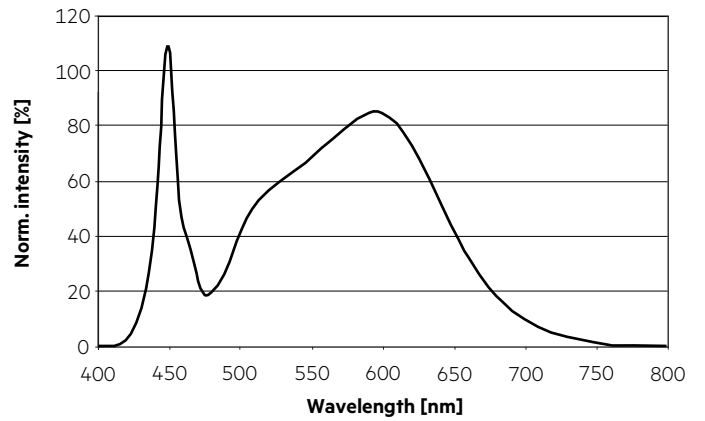

6.2 Light distribution

The optical design of the SLE product line ensures optimum homogeneity for the light distribution.

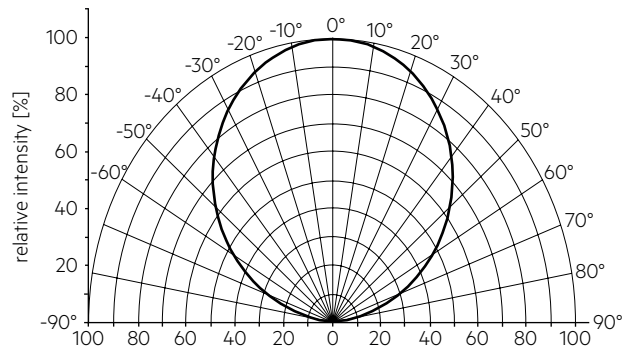

6.3 Relative luminous flux vs. tp temperature

SLE 09mm 800lm ADV8

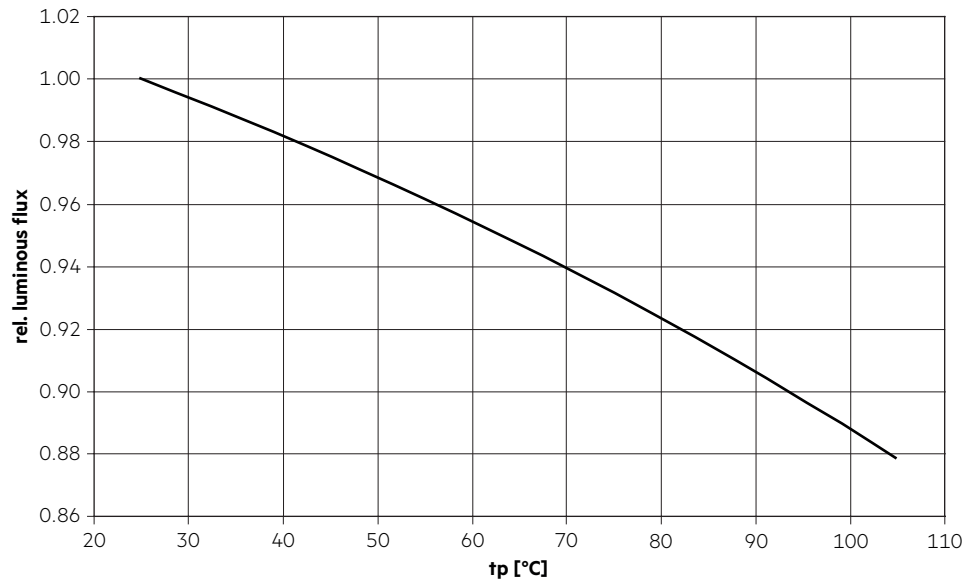

SLE 09mm 1200lm ADV8

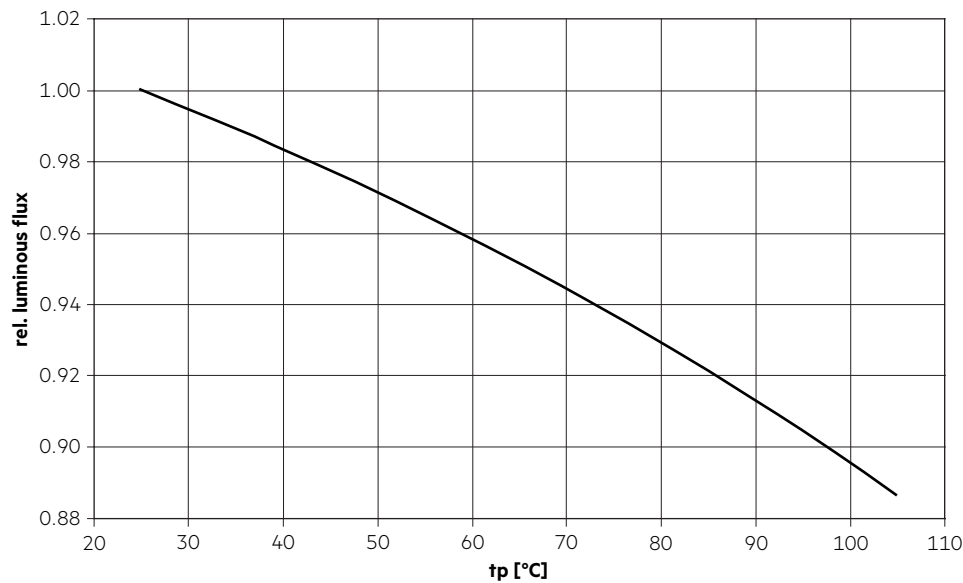

SLE 13mm 3000lm ADV8

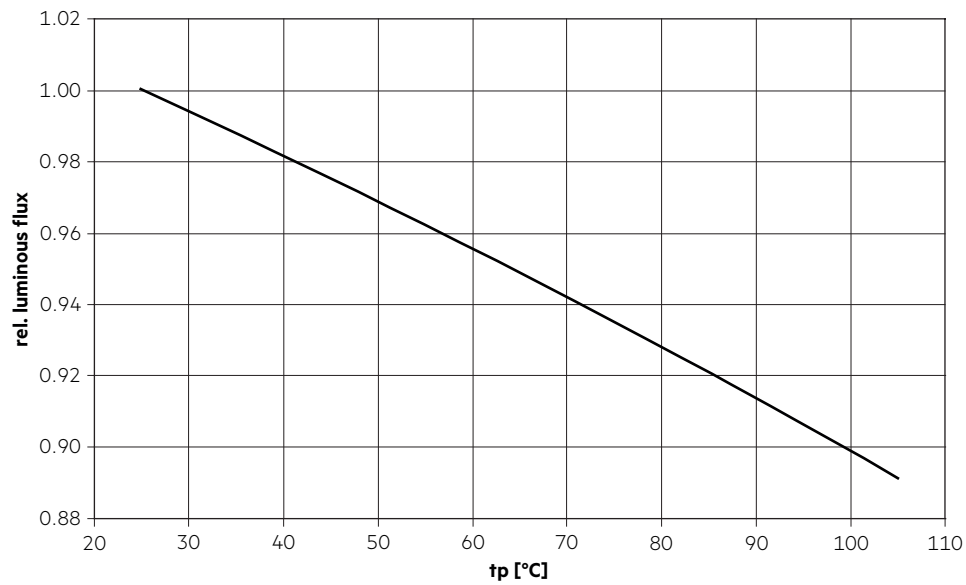

SLE 15mm 4000lm ADV8

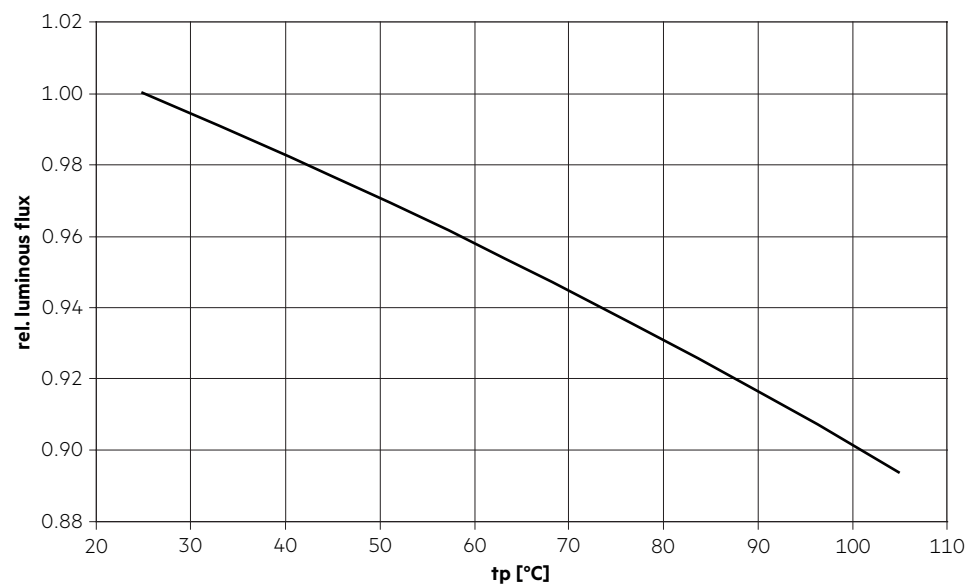

SLE 17mm 5000lm ADV8

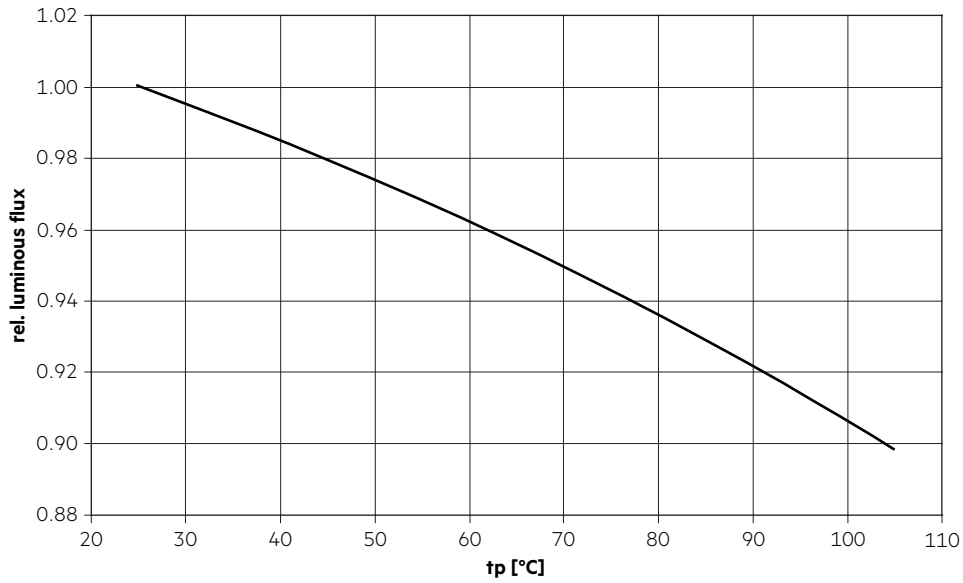

SLE 21mm 6000lm ADV8

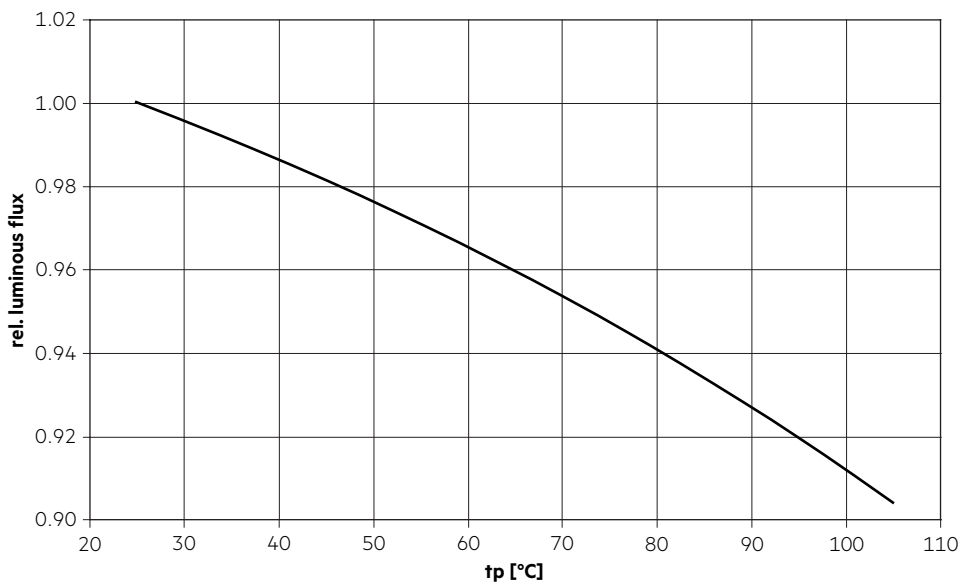

6.4 Relative luminous flux vs. operating current

SLE 09mm 800lm ADV8

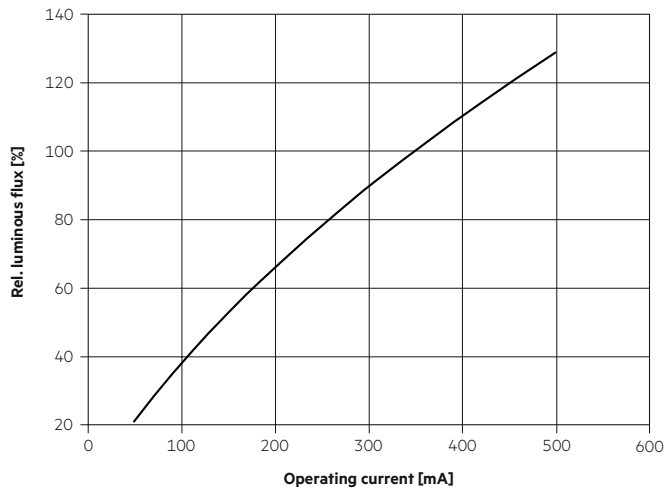

SLE 09mm 1200lm ADV8

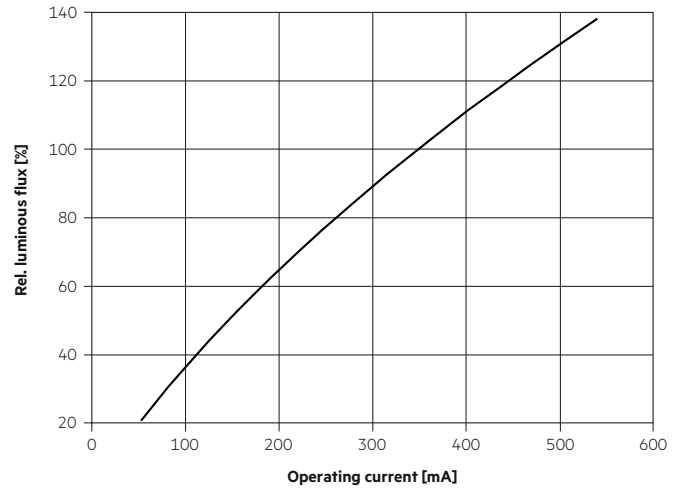

SLE 13mm 3000lm ADV8

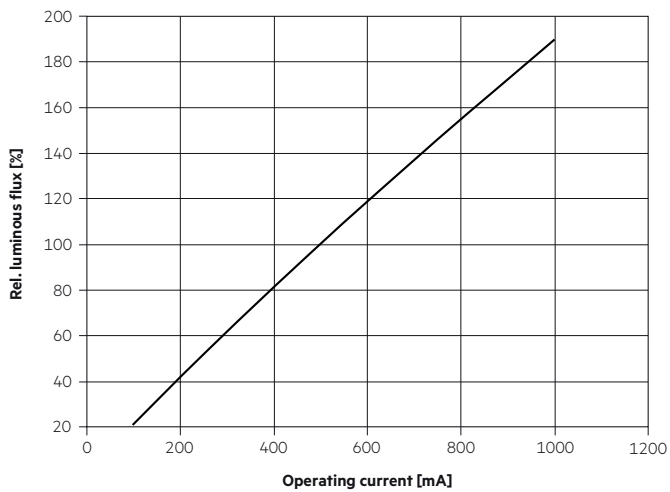

SLE 15mm 4000lm ADV8

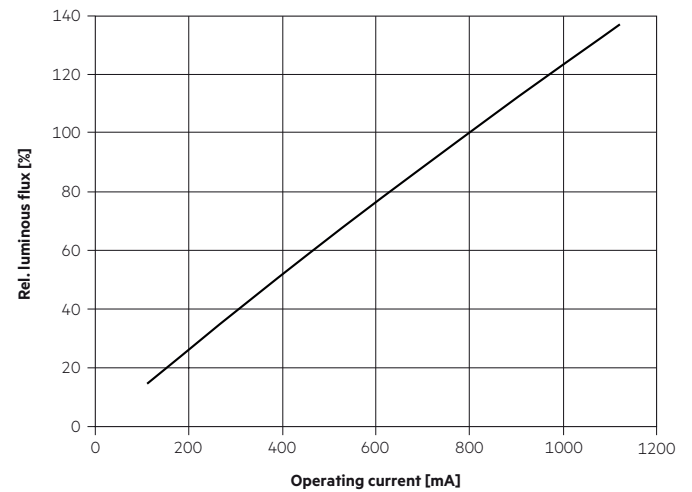

SLE 17mm 5000lm ADV8

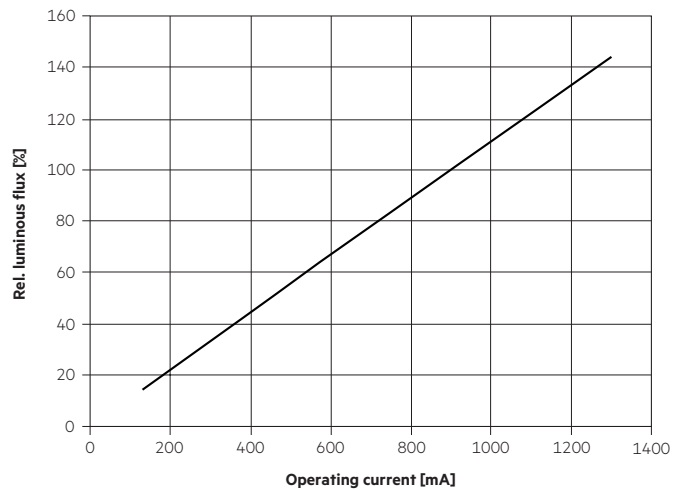

SLE 21mm 6000lm ADV8

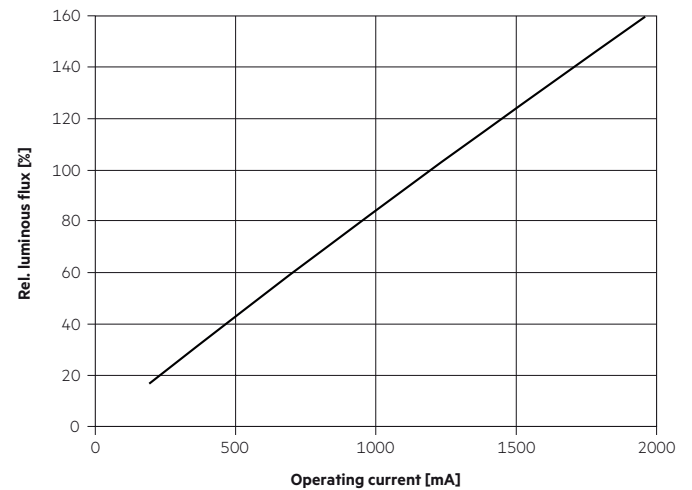

7. Miscellaneous

7.1 Additional information

Additional technical information at www.tridonic.com → Technical Data

Energy label and further information at www.tridonic.com in the certificates tab of the corresponding product page and at the EPREL data base <https://eprel.ec.europa.eu/>

Guarantee conditions at www.tridonic.com → Services

Lifetime declarations are informative and represent no warranty claim.